

EN
OWNER'S MANUAL

FR
MANUEL
DE L'UTILISATEUR

ES
MANUAL
DEL PROPIETARIO

DE
BENUTZERHANDBUCH

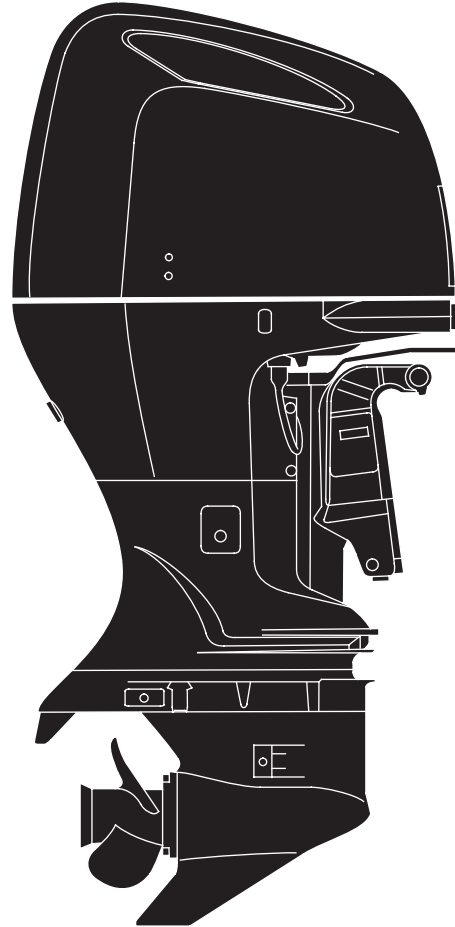

TOHATSU

BFT 250A

OWNER'S MANUAL

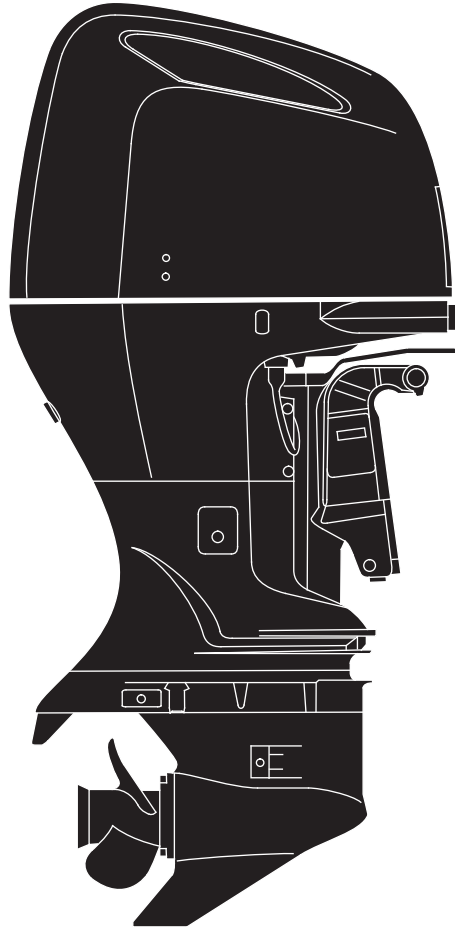

TOHATSU

BFT 250A
Original instructions

Thank you for purchasing a TOHATSU Outboard Motor.

This manual covers operation and maintenance of the TOHATSU BFT250A Outboard Motor.

All information in this publication is based on the latest product information available at the time of approval for printing.

Tohatsu Corporation reserves the right to make changes at any time without notice and without incurring any obligation.

No part of this publication may be reproduced without written permission.

This manual should be considered a permanent part of the Outboard Motor and should remain with it if it is resold.

Throughout this manual, you will see safety messages preceded by the following words and symbols. Here's what they mean:

▲ DANGER

Indicates serious injury or death WILL result if instructions are not followed.

▲ WARNING

Indicates a strong possibility that serious personal injury or death may result if instructions are not followed.

▲ CAUTION

Indicates a possibility that personal injury or equipment damage could result if instructions are not followed.

NOTICE

Indicates that equipment or property damage could result if instructions are not followed.

NOTE: Gives helpful information.

If a problem should arise, or if you have any questions about the Outboard Motor, consult an authorized TOHATSU Outboard Motor dealer.

▲ WARNING

TOHATSU Outboard Motors are designed to give safe and dependable service if operated according to instructions. Read and understand the Owner's Manual before operating the Outboard Motor. Failure to do so could result in personal injury or equipment damage.

Model	BFT250A	
Type	XD	XU
Transom Height	508 mm (20.0 in)	
(Shaft Length)	635 mm (25.0 in)	•
Standard Rotating Propeller Shaft	•	•
Power Trim/Tilt	•	•

BFT250A is provided with the following types according to the shaft length and the rotating direction of the propeller shaft.

TYPE CODE
Example

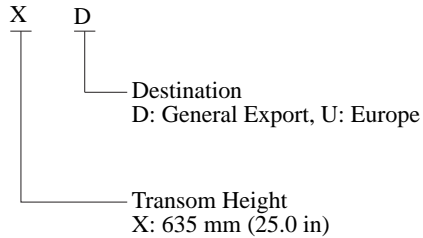

The remote control type is classified into the following three categories according to the control box position.

Side-mount type: R1 type

Panel-mount type: R2 type

Top-mount type: R3 type

Check the type of your outboard motor and read this Owner's Manual thoroughly before operation.

Texts with no type indication are the information and/or procedures common to all types.

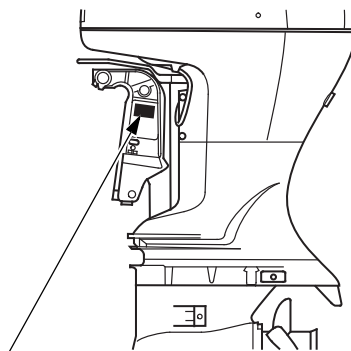

FRAME SERIAL NUMBER

Record the frame and engine serial numbers for your reference. Refer to the serial numbers when ordering parts, and when making technical or warranty inquiries.

The frame serial number is stamped on a plate attached on the left side of the stern bracket.

Frame serial number:

ENGINE SERIAL NUMBER

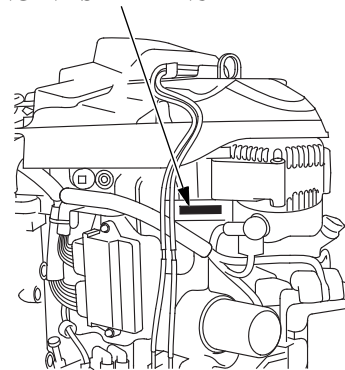

The engine serial number is stamped on the upper right side of the engine.

Engine serial number:

CONTENTS

1. SAFETY	6	5. INSTALLATION	30
SAFETY INFORMATION	6	Transom Height	30
2. SAFETY LABEL LOCATIONS	8	Location	31
3. COMPONENT IDENTIFICATION	10	Installation Height	31
4. CONTROLS AND FEATURES	15	Outboard Motor Installation	32
Remote Control Lever	15	Outboard Motor Angle Inspection (Cruising)	33
R1 type	15	Battery Connections	34
R2 type	16	Remote Control Installation (optional equipment)	36
R3 type	17	Remote Control Box Location	37
Neutral Release Lever	18	Remote Control Cable Length	37
Engine Switch	18	Propeller Selection	38
Fast Idle Lever/Fast Idle Button	19	Fuel Line Connection	38
PGM-FI Indicator/Buzzer	20	6. PRE-OPERATION CHECKS	39
ACG Indicator/Buzzer	20	Engine Cover Removal/Installation	39
Oil Pressure Indicator/Buzzer	21	Engine Oil	40
Overheat Indicator/Buzzer	21	Fuel	42
Water Separator Buzzer	21	GASOLINE CONTAINING ALCOHOL	43
Power Trim/Tilt Switch	22	Propeller and Cotter Pin Inspection	44
Trim Meter (optional equipment)	23	Remote Control Lever Friction	45
Power Tilt Switch (outboard motor pan)	23	Fuel Filter	45
Manual Relief Valve	24	Battery	46
Emergency Stop Switch	25	Other Checks	47
Emergency Stop Switch Lanyard/Clip	25	7. STARTING THE ENGINE	48
Spare Emergency Stop Switch Clip	26	Fuel Priming	48
Tilt Lock Lever	27	Starting the Engine	48
Trim Tab	27	R1 type	48
Anode	27	R2, R3 type	52
Cooling Water Check Hole	28		
Cooling Water Intake Port	28		
Engine Cover Latch	28		
Tachometer (optional equipment)	29		
NMEA Interface Coupler	29		

CONTENTS

8. OPERATION	56	Engine Oil	84
Break-in Procedure	56	Spark Plugs	86
Gear Shifting	57	Standard Spark Plug	86
R1 type	57	Optional Parts: Iridium Spark Plug	89
R2 type	58	Lubrication	90
R3 type	59	Fuel Filter	91
Cruising	60	Water Separator	94
Trimming the Outboard Motor	62	EMISSION CONTROL SYSTEM	97
Trim Meter	64	Battery	98
Tilting the Outboard Motor	65	Fuse	100
Moorage	66	ACG Fuse	101
Power Tilt Switch	67	Propeller	102
Manual Relief Valve	67	Inspect After Operating	103
Trim Tab Adjustment	68	Submerged Outboard Motor	103
Engine Protection System	69	13. STORAGE	105
<Engine Oil Pressure, Overheat, Water Separator, PGM-FI and ACG Warning Systems>	69	Fuel	105
<Over-rev Limiter>	73	Vapor Separator Draining	106
<Anode>	73	Battery Storage	107
Shallow Water Operation	73	Outboard Motor Position	108
Multiple Outboard Motors	74	14. DISPOSAL	109
9. STOPPING THE ENGINE	75	15. TROUBLESHOOTING	110
Emergency Engine Stop	75	16. SPECIFICATIONS	112
Normal Engine Stop	75	17. “EC DECLARATION OF CONFORMITY” CONTENT OUTLINE	114
10. TRANSPORTING	77	18. INDEX	119
Fuel Line Disconnection	77		
Transporting	77		
Trailing	78		
11. CLEANING AND FLUSHING	79		
12. MAINTENANCE	80		
Tool Kit and Spare Parts	81		
MAINTENANCE SCHEDULE	82		

1. SAFETY

SAFETY INFORMATION

For your safety and the safety of others, pay special attention to these precautions.

Operator Responsibility



- **TOHATSU outboard motor is designed to give safe and dependable service if operated according to instructions.**

Read and understand the Owner's Manual before operating the outboard motor. Failure to do so could result in personal injury or equipment damage.



Shift to the neutral position and then shift to the reverse position at low engine speed. Do not shift to the reverse position suddenly at high engine speed.

- Gasoline is harmful or fatal if swallowed. Keep the fuel tank out of reach of children.
- Gasoline is extremely flammable and is explosive under certain conditions. Refuel in a well-ventilated area with the engine stopped.
- Do not smoke or allow flames or sparks where the engine is refueled or where gasoline is stored.
- Do not overfill the fuel tank. After refueling make sure that the fuel tank cap is closed properly and securely.

- Be careful not to spill any fuel while refueling. Spilled fuel or fuel vapor may ignite. If any fuel is spilled make sure that the area is dry before starting the engine.
- Know how to stop the engine quickly in case of emergency. Understand the use of all controls.
- Do not exceed the boat manufacturer's power recommendation, and be sure that the outboard motor is properly mounted.
- Never permit anyone to operate the outboard motor without proper instruction.
- Before operating the outboard motor, familiarize yourself with all laws and regulations relating to boating and the use of outboard motors.
- Do not attempt to modify the outboard motor.
- Always wear a life-jacket when on board.

- Do not operate the outboard motor without the engine cover. Exposed moving parts can cause injury.
- Do not remove any guards, labels, shields, covers or safety devices; they are installed for your safety.
- Stop the engine immediately if anyone falls overboard.
- Do not run the engine while the boat is near anyone in the water.
- Attach the emergency stop switch lanyard securely to the operator.

The engine and exhaust system become very hot during operation and remain hot for a while after stopping. Contact with hot engine components can cause burns and may ignite some materials.

- Avoid touching a hot engine or exhaust system.
- Allow the engine to cool before performing maintenance or transporting.

Carbon Monoxide Poisoning Hazard

Exhaust contains poisonous carbon monoxide, a colorless and odorless gas. Breathing exhaust can cause loss of consciousness and may lead to death.

- If you run the engine in an area that is confined, or even partially enclosed, the air can become contaminated with a dangerous amount of exhaust gas. To keep exhaust gas from building up, provide adequate ventilation.

2. SAFETY LABEL LOCATIONS

These labels are in the locations shown.

They warn you of potential hazards that can cause serious injury.

Read the labels and safety notes and precautions described in this manual carefully.

If a label comes off or becomes hard to read, contact your TOHATSU outboard motor dealer for a replacement.

READ OWNER'S MANUAL



**READ OWNER'S MANUAL
GEAR SHIFTING**

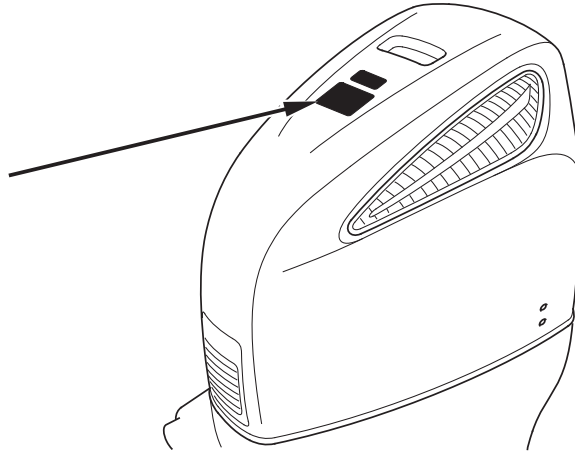
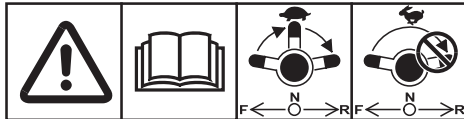

SAFETY LABEL LOCATIONS

CE mark location [U type only]

CE MARK

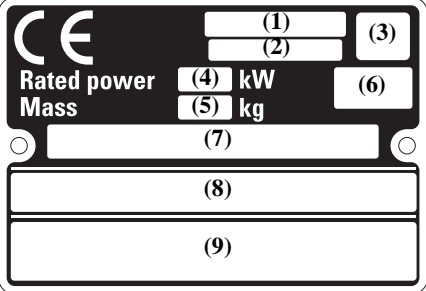

(1) Model name
 (2) Engine family name
 (3) Year code
 (4) Rated power
 (5) Dry mass (weight) (with propeller, without battery cable)
 (6) Country of manufacture
 (7) Frame number
 (8) Manufacturer and address
 (9) Name and address of authorized representative

Year code	D	E	F	G	H	J
Year of manufacture	2013	2014	2015	2016	2017	2018

Name and address of manufacturer and authorized representative are written in the “EC Declaration of Conformity” CONTENT OUTLINE in this Owner’s Manual.

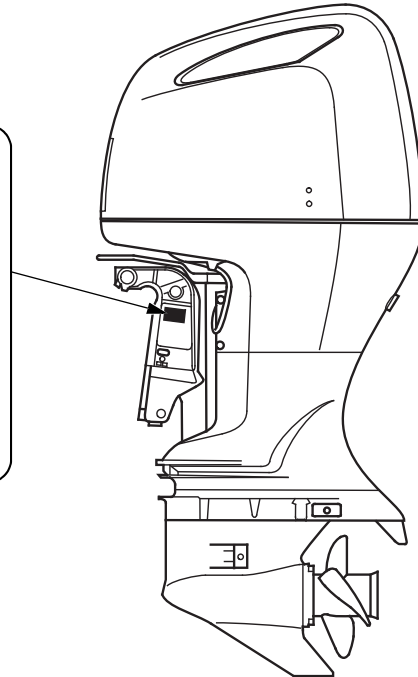

3. COMPONENT IDENTIFICATION

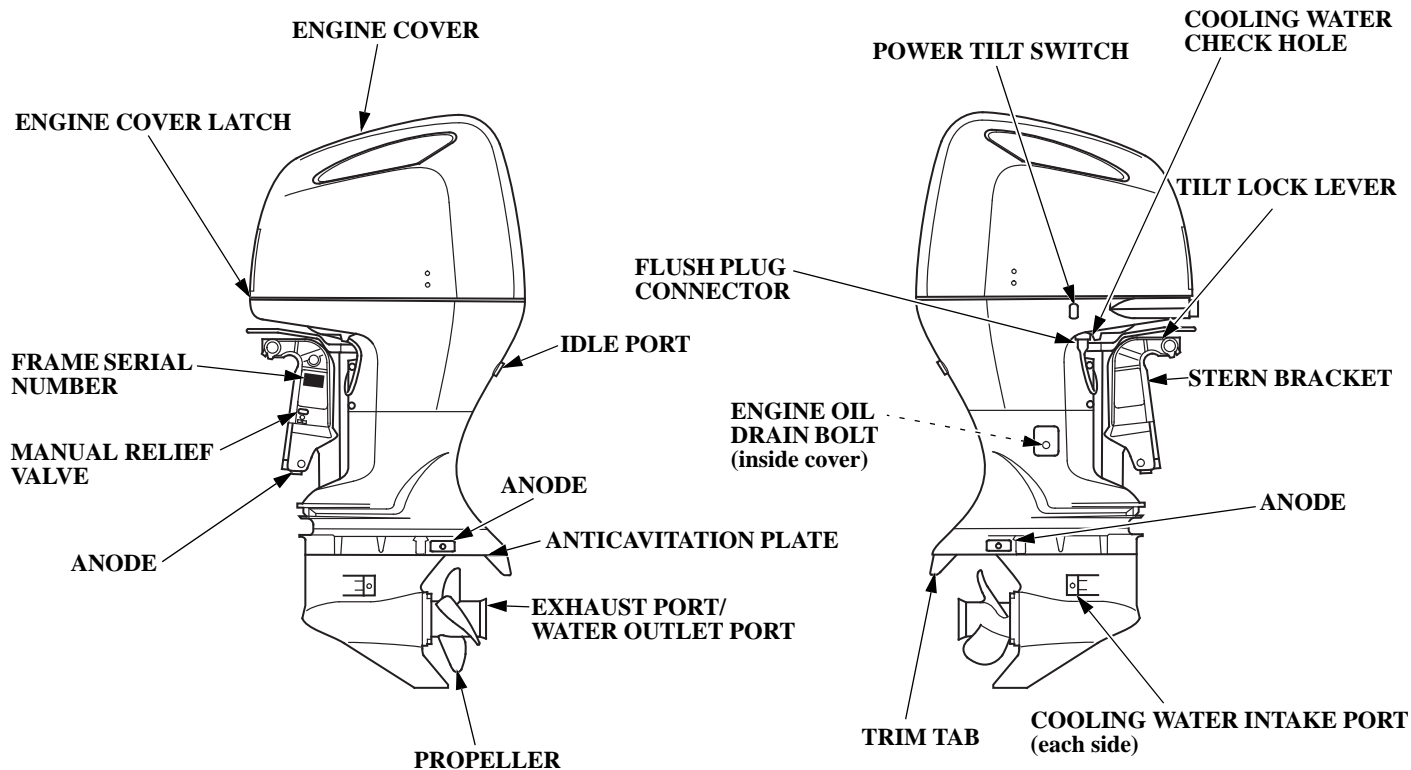

COMPONENT IDENTIFICATION

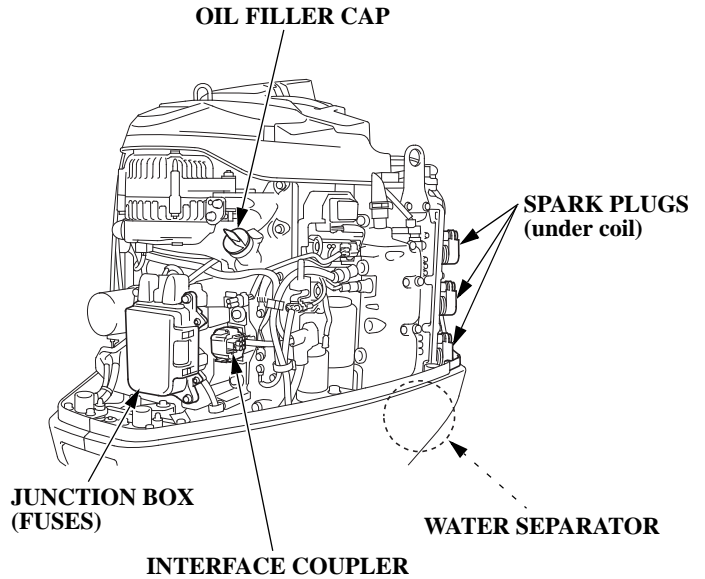
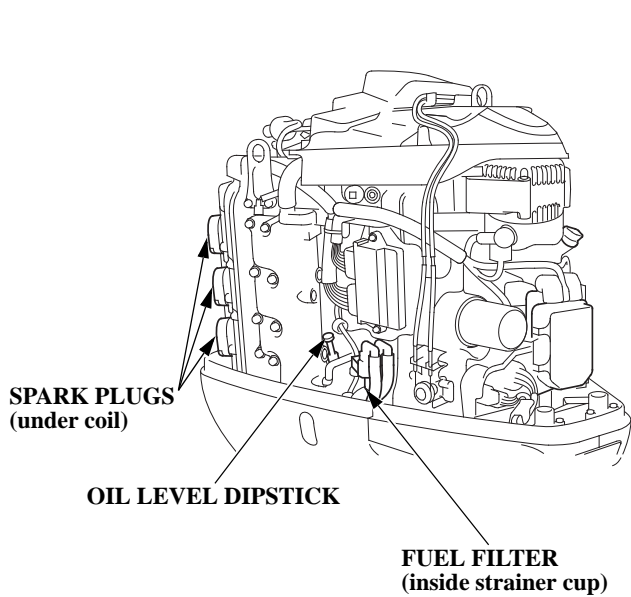

COMPONENT IDENTIFICATION

REMOTE CONTROL BOX

(optional equipment)

SIDE-MOUNT TYPE (R1 type)

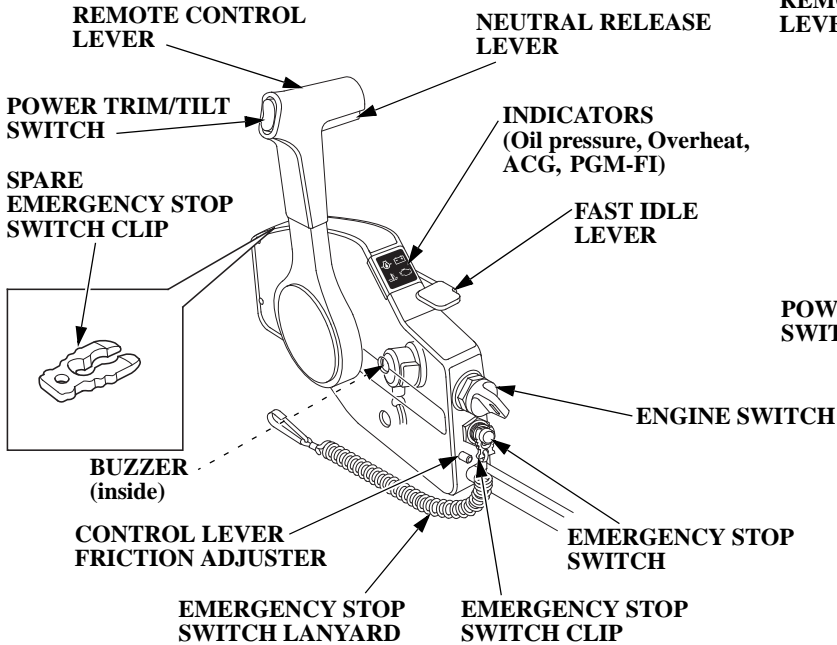

PANEL-MOUNT TYPE (R2 type)

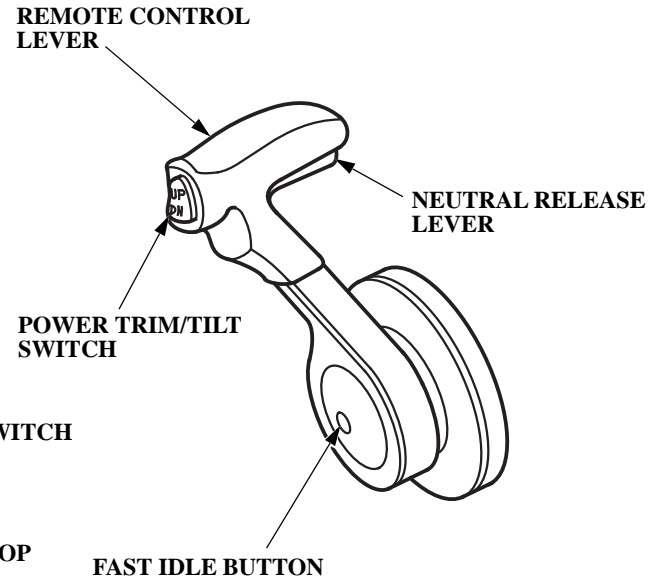

COMPONENT IDENTIFICATION

TOP-MOUNT TYPE (R3 type) (SINGLE OUTBOARD MOTOR TYPE)

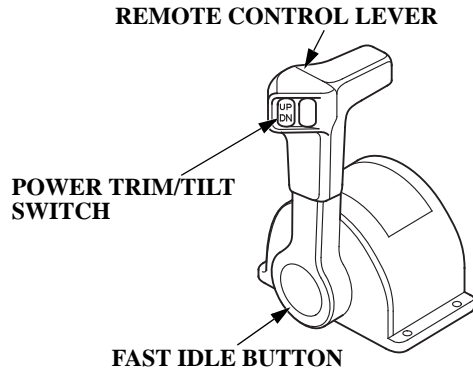

(DUAL OUTBOARD MOTOR TYPE)

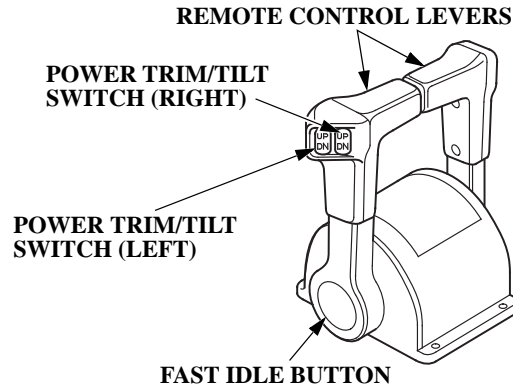

SWITCH PANEL (optional equipment) (PANEL-MOUNT, TOP-MOUNT)

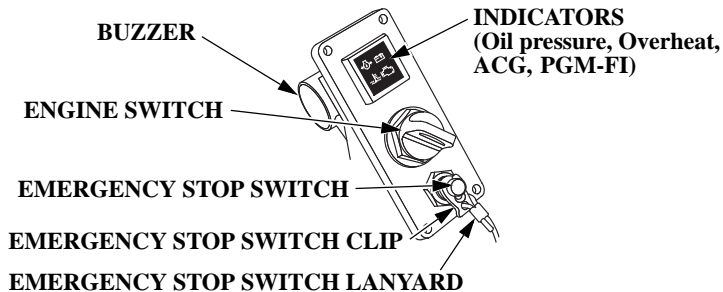

(for TOP-MOUNT DUAL type)

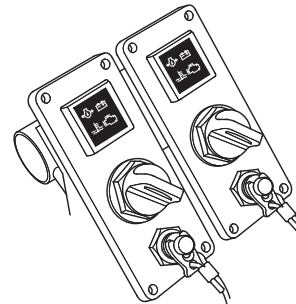

COMPONENT IDENTIFICATION

(Common)

TACHOMETER (Optional equipment)

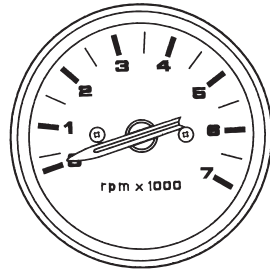

TRIM METER (Optional equipment)

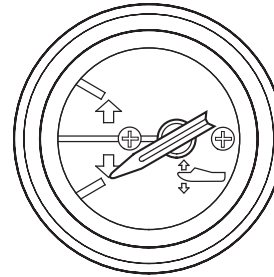

4. CONTROLS AND FEATURES

Remote Control Lever (R1 type)

REMOTE CONTROL LEVER

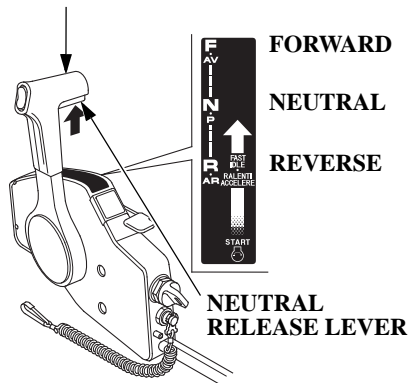

Shifting gear into forward, reverse, or neutral and the engine speed adjustment can be performed with the remote control lever.

It is necessary to pull up the neutral release lever to operate the remote control lever.

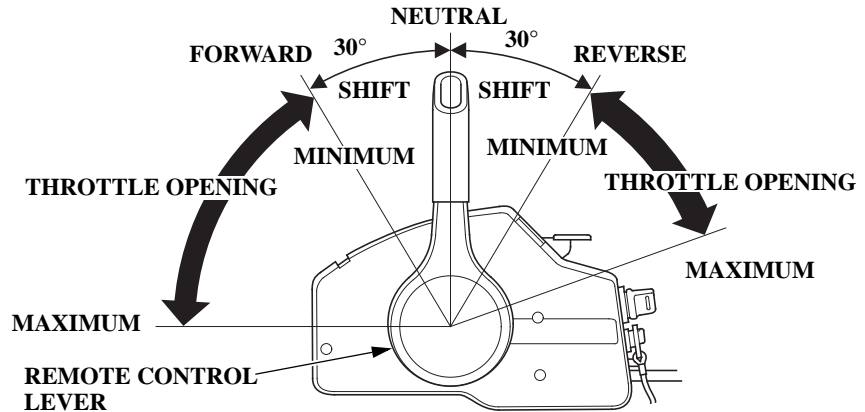

FORWARD:

Moving the lever to the FORWARD position (i.e. approximately 30° from the NEUTRAL position) engages the gear into forward. Moving the lever further from the FORWARD position will increase the throttle opening and the boat forward speed.

NEUTRAL:

Engine power is cut off from the propeller.

REVERSE:

Moving the lever to the REVERSE position (i.e. approximately 30° from the NEUTRAL position) engages the gear into reverse. Moving the lever further from the REVERSE position will increase the throttle opening and the boat reverse speed.

CONTROLS AND FEATURES

Remote Control Lever (R2 type)

REMOTE CONTROL LEVER

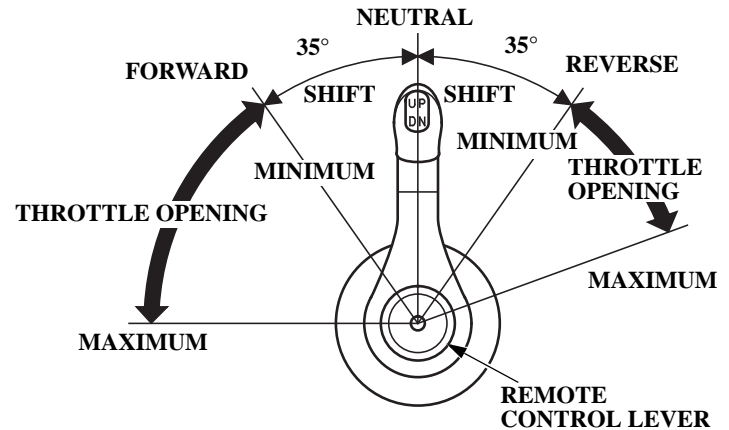
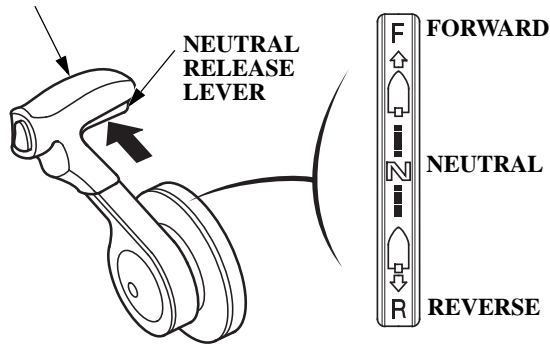

Shifting gear into forward, reverse, or neutral and the engine speed adjustment can be performed with the remote control lever.

It is necessary to pull up the neutral release lever to operate the remote control lever.

FORWARD:

Moving the lever to the FORWARD position (i.e. approximately 35° from the NEUTRAL position) engages the gear into forward. Moving the lever further from the FORWARD position will increase the throttle opening and the boat forward speed.

NEUTRAL:

Engine power is cut off from the propeller.

REVERSE:

Moving the lever to the REVERSE position (i.e. approximately 35° from the NEUTRAL position) engages the gear into reverse. Moving the lever further from the REVERSE position will increase the throttle opening and the boat reverse speed.

CONTROLS AND FEATURES

Remote Control Lever (R3 type)

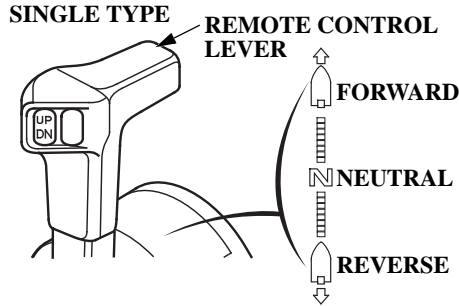

DUAL TYPE

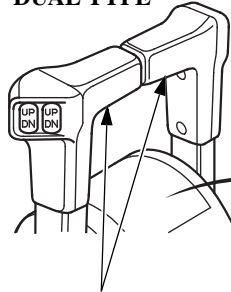

REMOTE CONTROL LEVERS

FORWARD NEUTRAL

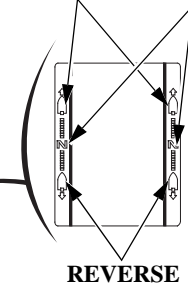

REVERSE

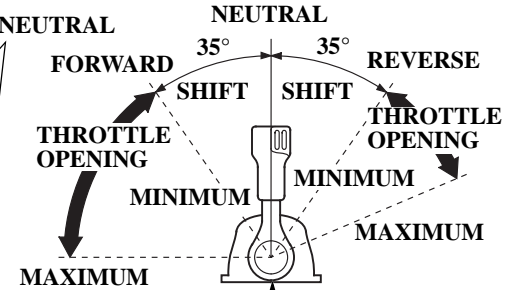

REMOTE CONTROL LEVER

Shifting gear into forward, reverse, or neutral and the engine speed adjustment can be performed with the remote control lever.

FORWARD:

Moving the lever to the FORWARD position (i.e. approximately 35° from the NEUTRAL position) engages the gear into forward. Moving the lever further from the FORWARD position will increase the throttle opening and the boat forward speed.

NEUTRAL:

Engine power is cut off from the propeller.

REVERSE:

Moving the lever to the REVERSE position (i.e. approximately 35° from the NEUTRAL position) engages the gear into reverse. Moving the lever further from the REVERSE position will increase the throttle opening and the boat reverse speed.

CONTROLS AND FEATURES

Neutral Release Lever

(R1 type)

REMOTE CONTROL LEVER

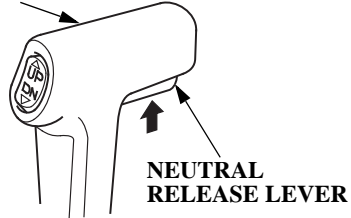

(R2 type)

REMOTE CONTROL LEVER

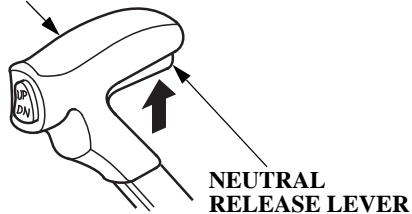

The neutral release lever is set on the remote control lever to prevent an accidental operation of the remote control lever.

The remote control lever does not operate unless it is moved while pulling the neutral release lever up.

Engine Switch

(R1 type)

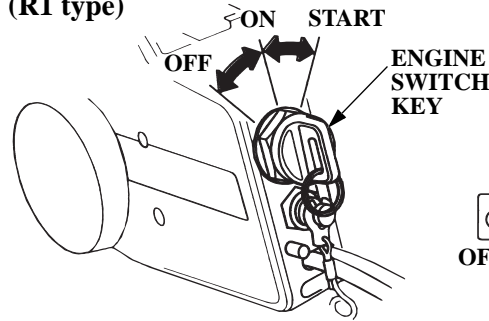

This remote control is equipped with an automotive type ignition switch. On the side-mount type (R1 type), the engine switch locates on your side near the remote control box. On the panel-mount type (R2 type) and the top-mount type (R3 type), the engine switch locates at the center of the control panel.

Key positions:

START: to start the engine.

ON: to run the engine after starting.

OFF: to stop the engine (IGNITION OFF).

(R2, R3 type)

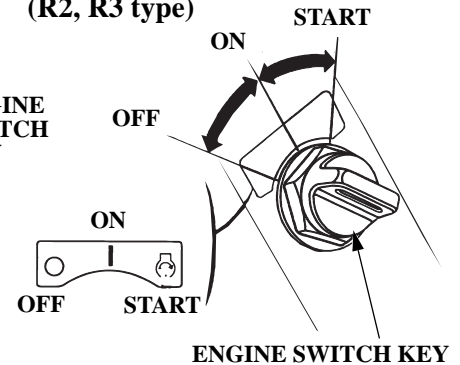

NOTICE

Do not leave the engine switch (ignition switch) ON (key in ON position) when the engine is not running as the battery will discharge.

NOTE:

The starter motor will not work unless the remote control lever is in the NEUTRAL position, and the clip is in the emergency stop switch.

CONTROLS AND FEATURES

Fast Idle Lever (R1 type)/Fast Idle Button (R2, R3 types)

The fast idle lever/fast idle button is only needed for starting carbureted outboard models. The BFT250A model use programmed fuel injection so, this lever will not be needed for starting.

After the engine starts and if the outside temperature is below 5°C (41°F), the fast idle lever/fast idle button can be used to accelerate engine warm up.

<Fast Idle Lever> (R1 type)

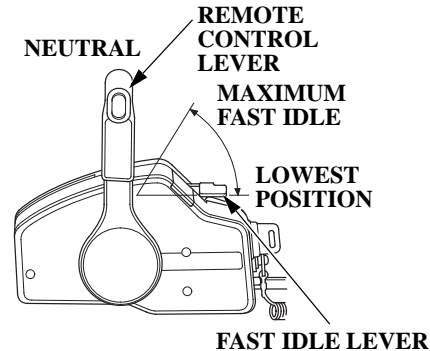

The fast idle lever will not move unless the remote control lever is in the NEUTRAL position. Conversely, the remote control lever will not move unless the fast idle lever is in the lowest position.

Lower the fast idle lever to the lowest position to decrease the fast idle.

<Fast Idle Button> (R2 type)

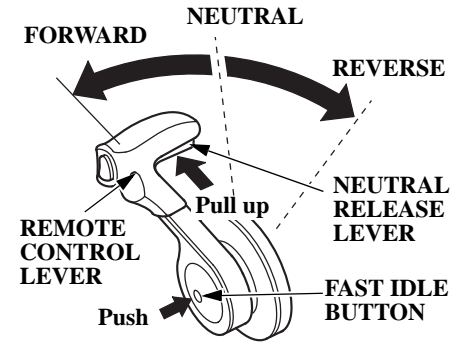

Pushing the fast idle button, turn the remote control lever forward. Keep turning the lever forward. The throttle opens and the engine speed increases after the lever passed the shift point. Note that the gearshift mechanism does not function when the fast idle button is pushed once and then released after the remote control lever is moved.

The control lever does not operate unless the neutral release lever is pulled.

CONTROLS AND FEATURES

<Fast Idle Button>

(R3 type)

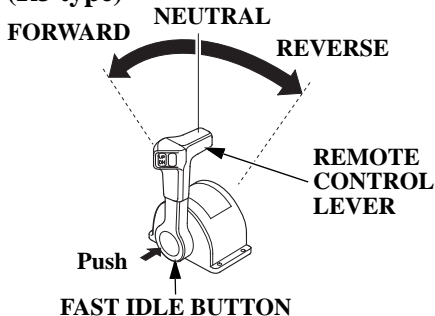

Use the fast idle button and the remote control lever to adjust the engine speed without gearshift when warming up the engine. Pushing the fast idle button, turn the remote control lever forward. Keep turning the lever forward. The throttle opens and the engine speed increases after the lever passed the shift point. Note that the gearshift mechanism does not function when the fast idle button is pushed once and then released after the remote control lever is moved.

PGM-FI Indicator/Buzzer (R1 type)

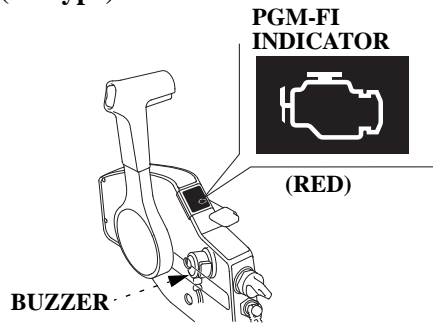

(R2, R3 type)

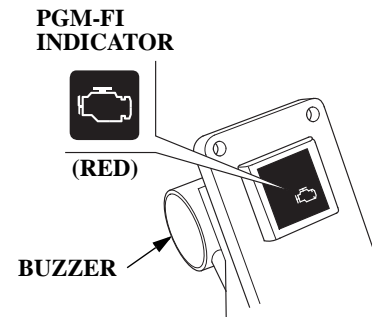

The PGM-FI indicator turns on and the buzzer sounds when the engine control system is faulty.

ACG Indicator/Buzzer (R1 type)

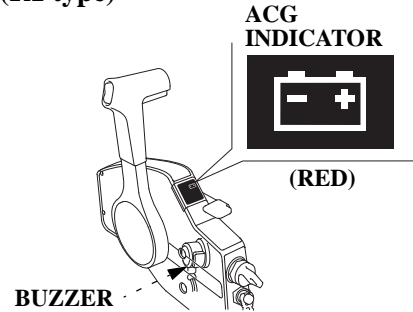

(R2, R3 type)

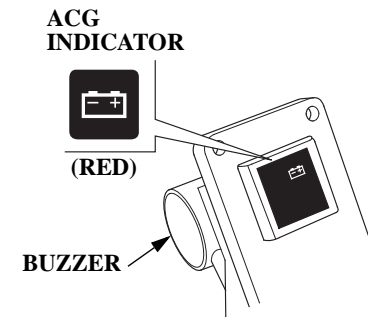

The ACG indicator turns on and the buzzer sounds when the charging system is faulty.

CONTROLS AND FEATURES

Oil Pressure Indicator/Buzzer

(R1 type)

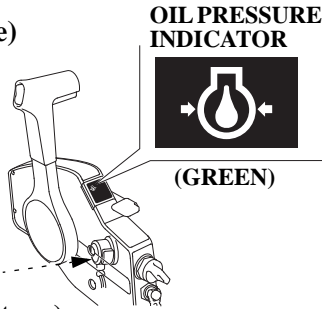

(R2, R3 type)

OIL PRESSURE
INDICATOR

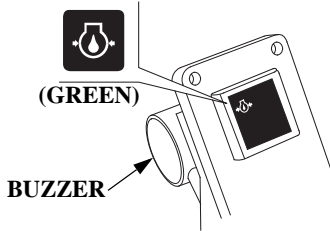

The oil pressure indicator turns off and the buzzer sounds when the oil level is low and/or the engine lubrication system is faulty. The engine speed slows down gradually this time.

Overheat Indicator/Buzzer

(R1 type)

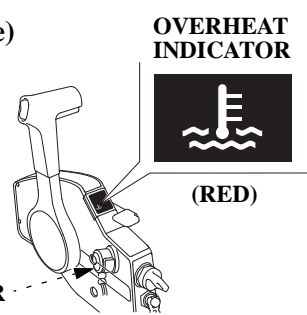

(R2, R3 type)

OVERHEAT
INDICATOR

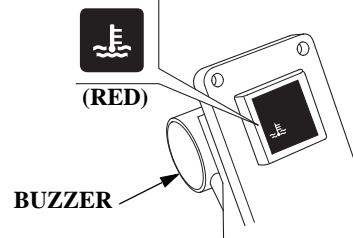

The overheat indicator turns on and the buzzer sounds when the engine cooling circuit is faulty. The engine speed slows down this time.

Water Separator Buzzer

The water separator buzzer sounds when water has accumulated in the water separator.

CONTROLS AND FEATURES

Power Trim/Tilt Switch

Power Trim

Press the power trim/tilt switch on the remote control lever to adjust the outboard motor trim angle of -4° to 16° to maintain proper boat trim. The power trim/tilt switch can be operated while the boat is under way or while stopped.

By using the power trim/tilt switch the operator can change the trim angle of the outboard motor to achieve maximum boat acceleration, speed, stability and maintain optimum fuel consumption.

NOTE:

The outboard motor trim angle of -4° to 16° is the angle when the outboard motor is installed on the boat at 12° .

(R1 type)

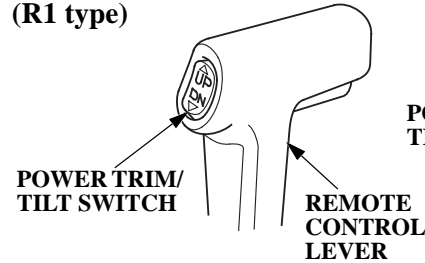

(R2 type)

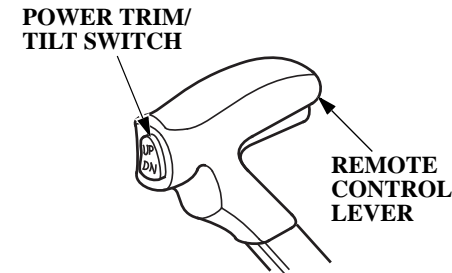

NOTICE

Excessive trim/tilt angle during operation can cause the propeller to raise out of the water and cause propeller ventilation and engine over-revving. Excessive trim/tilt angle can also damage the water pump.

(R3 type)

SINGLE TYPE

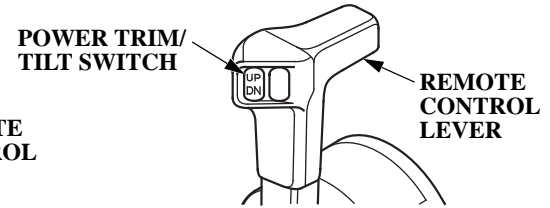

(R3 type)

DUAL TYPE

POWER TRIM/TILT SWITCH

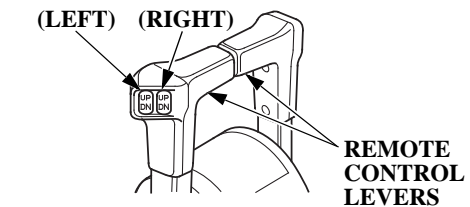

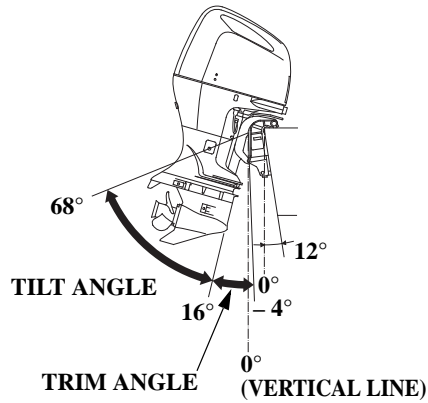

(when transom angle is 12°)

Power Tilt

Press the power trim/tilt switch to adjust the outboard motor tilt angle of 16° to 68°.

By using the power trim/tilt switch the operator can change the tilt angle of the outboard motor for shallow water operation, beaching, launching from a trailer, or mooring. Please tilt up simultaneously, when you mount the dual type outboard motor.

Trim Meter (optional equipment)

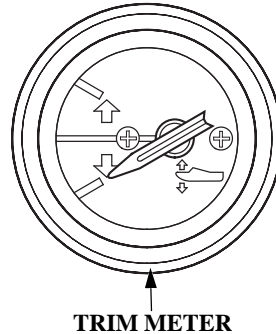

The trim meter has a range of -4° to 16° and indicates the trim angle of the outboard motor. Refer to the trim meter when using the power trim/tilt switch to achieve proper boat performance.

NOTE:

The outboard motor trim angle of -4° to 16° is the angle when the outboard motor is installed on the boat at 12°.

Power Tilt Switch (outboard motor pan)

POWER TILT SWITCH

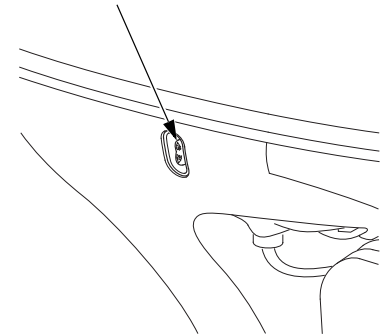

The power tilt switch located on the outboard motor pan is a convenience switch for tilting the outboard motor for trailering, or performing outboard maintenance. This power tilt switch should only be operated with the boat being stopped and engine off.

CONTROLS AND FEATURES

Manual Relief Valve

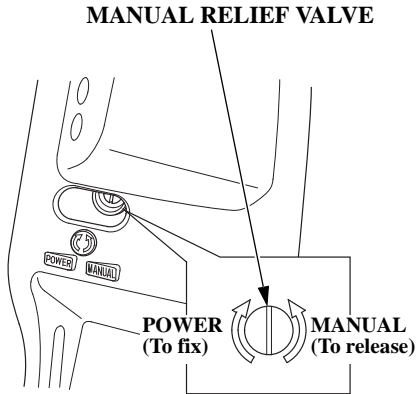

If the power trim/tilt switch will not tilt the outboard motor, the outboard motor can be manually tilted up or down by opening the manual relief valve. To tilt the outboard motor manually, turn the manual relief valve under the left stern bracket no more than 1 or 2 turns counterclockwise using a screwdriver.

After tilting the outboard motor, turn the manual relief valve clockwise securely.

The manual relief valve must be tightened securely before operating the outboard motor or the outboard motor could tilt up when operating in reverse.

Emergency Stop Switch

The emergency stop switch lanyard is provided to stop the engine immediately in the event the operator should fall overboard or away from the controls.

(R1 type)

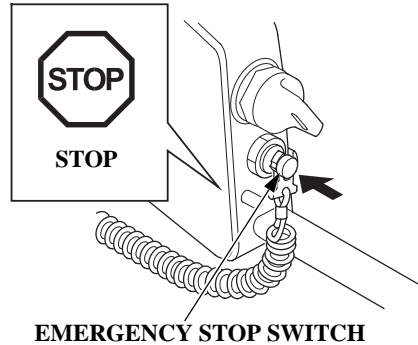

(R2, R3 type)

EMERGENCY STOP SWITCH

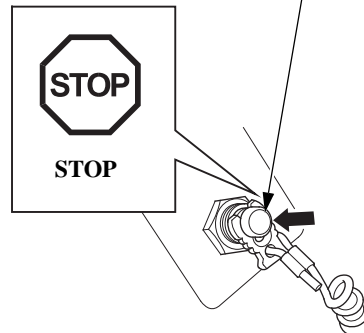

Emergency Stop Switch Lanyard/Clip

EMERGENCY STOP SWITCH LANYARD

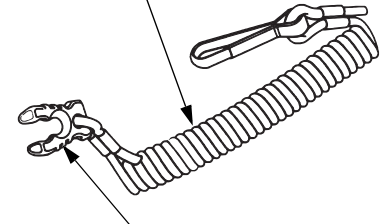

EMERGENCY STOP SWITCH CLIP

The emergency stop switch clip must be engaged with the emergency stop switch or the engine will not start. When the emergency stop switch clip becomes disengaged with the emergency stop switch the engine will stop immediately.

CONTROLS AND FEATURES

▲WARNING

If the emergency stop switch lanyard is not set, the boat might run out of control when the operator, for example, falls overboard and is not able to operate the outboard motor.

For the sake of the operator's and the passengers' safety, be sure to set the emergency stop switch clip located at one end of the emergency stop switch lanyard with the emergency stop switch. Attach the other end of the emergency stop switch lanyard securely to the operator.

(R1 type)

EMERGENCY STOP SWITCH

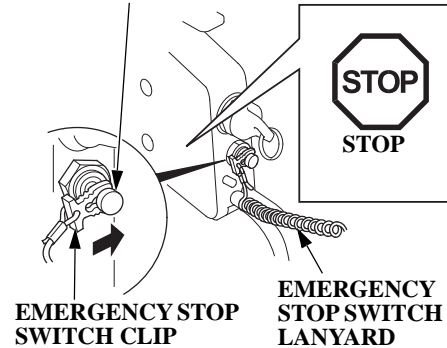

(R2, R3 type)

EMERGENCY STOP SWITCH

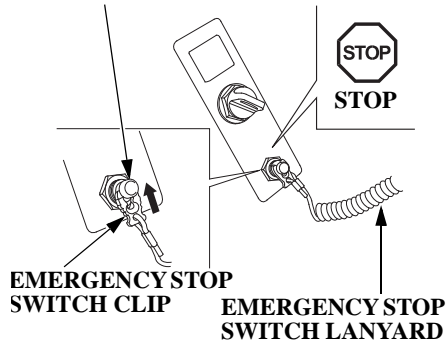

Spare Emergency Stop Switch Clip

(R1 type)

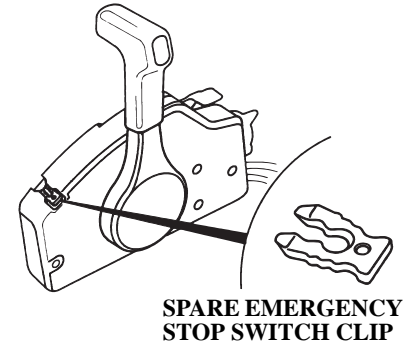

A spare emergency stop switch clip is provided on the remote control box.

(R2, R3 type)

A spare emergency stop switch clip does not come with R2, R3 type. A spare emergency stop switch clip is available from your outboard motor dealer. A spare emergency stop switch clip can be stored in the tool bag (see page 81).

Tilt Lock Lever

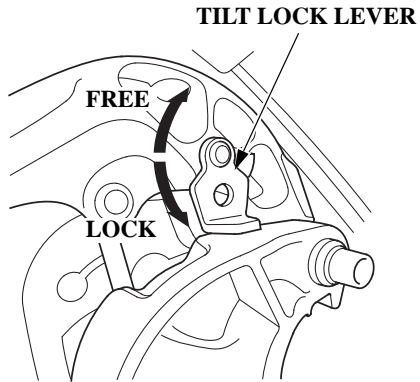

Use the tilt lock lever to raise the outboard motor and lock it in the position when the boat is moored or anchored for a long time.

Tilt the outboard motor as far as it goes and move the lock lever in the locking direction.

Trim Tab

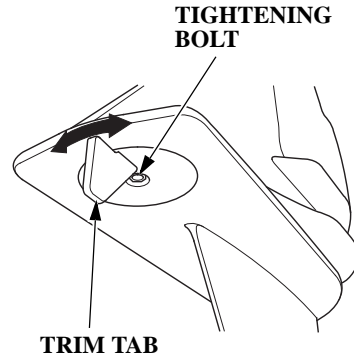

If the steering wheel/handle is pulled to the side while running at full speed, adjust the trim tab so that the boat runs straight ahead.

Loosen the tightening bolt and turn the trim tab right or left to adjust.

Anode

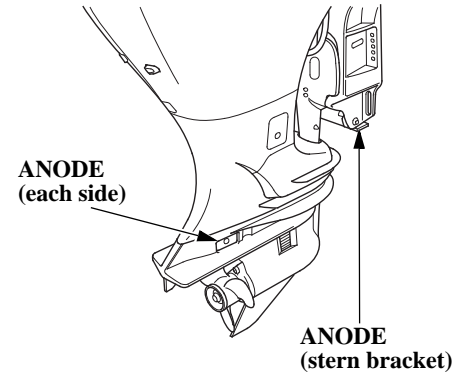

The anode is a sacrificial material which helps to protect the outboard motor from corrosion.

NOTICE

Do not paint the anode. It deteriorates the function of the anode, which can lead to rust and corrosion damage to the outboard motor.

CONTROLS AND FEATURES

Cooling Water Check Hole

COOLING WATER CHECK HOLE

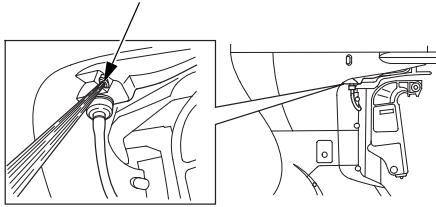

The cooling water is checked here to see whether it is circulating inside the engine properly.

After starting the engine, check at the cooling water check hole whether the cooling water is circulating through the engine.

Cooling Water Intake Port

COOLING WATER INTAKE PORT
(each side)

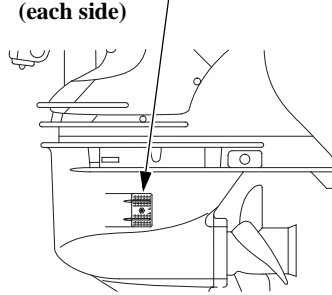

The engine cooling water is drawn into the engine through this port.

Engine Cover Latch

ENGINE COVER LATCH

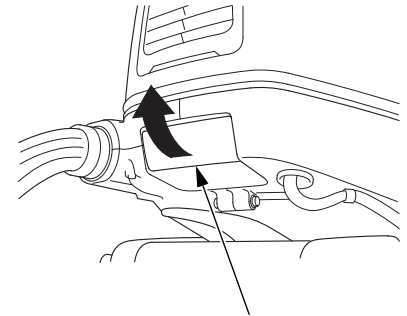

Pull the engine cover latch to remove the engine cover.

Tachometer (optional equipment)

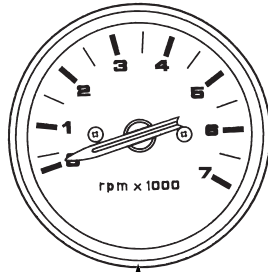

TACHOMETER

The tachometer shows the engine speed in revolutions per minute.

NMEA Interface Coupler

The NMEA2000 interface coupler can provide information regarding engine speed, fuel consumption, and various warnings to an existing NMEA2000 network via an optional interface cable. Contact your dealer for more information.

NMEA INTERFACE COUPLER

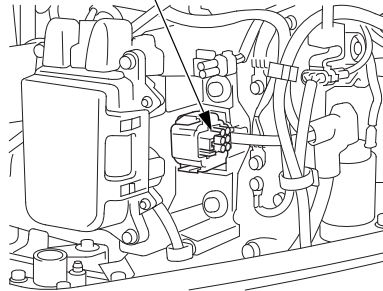

5. INSTALLATION

NOTICE

Improperly installed outboard motor can result in the outboard motor dropped into the water, boat not able to cruise straight ahead, engine speed not increase, and much fuel consumption.

We recommend that the outboard motor be installed by an authorized TOHATSU outboard motor dealer. Consult the authorized TOHATSU dealer in your area for the Y-OP (User Optional Parts)/equipments installation and operation.

Applicable Boat

Select the boat suitable for the engine power.

Engine power:
183.9 kW (250 PS)

Power recommendation is indicated on most of the boats.

⚠WARNING

Do not exceed the boat manufacturer's power recommendation. Damage and injury may result.

Transom Height

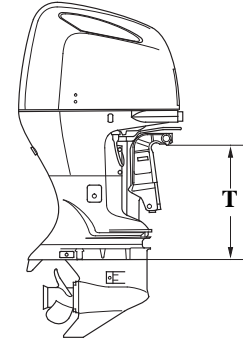

Type:	T (Transom Height) (when transom angle is 12°)
X:	635 mm (25.0 in)

Select the outboard motor which is correct for the boat transom height of your boat.

Location

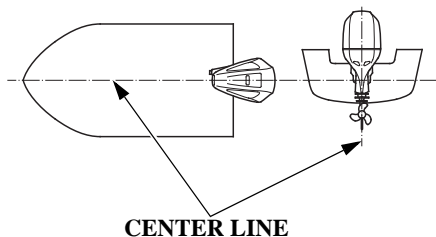

Install the outboard motor at the stern, at the center line of the boat.

Installation Height

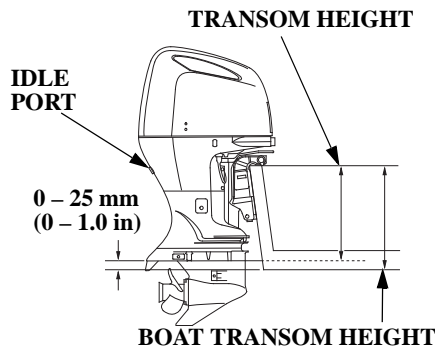

Make sure that the boat transom height is correct for the outboard motor. Incorrect installation height will reduce performance. The outboard motor should be installed so that the anticavitation plate is 0 – 25 mm (0 – 1.0 in) upper the bottom of the boat. The correct dimensions differ according to the type of the boats and the figuration of the bottom of the boats. Follow the manufacture's recommended installation height.

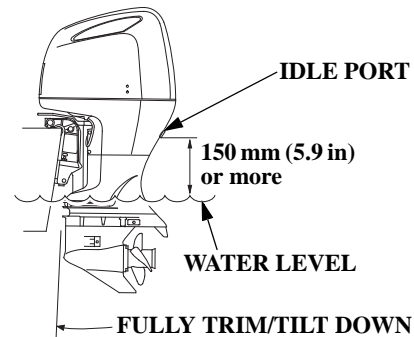

NOTICE

- The water level must be at least **100 mm (4 in)** above the anticavitation plate, otherwise the water pump may not receive sufficient cooling water, and the engine will overheat.
- Adverse effect to the engine can occur if the installation position of the outboard motor is too low. Trim/tilt down the outboard motor with the boat fully loaded and stop the engine. Check that the idle port is **150 mm (5.9 in)** or more above the water level.

INSTALLATION

Outboard Motor Installation

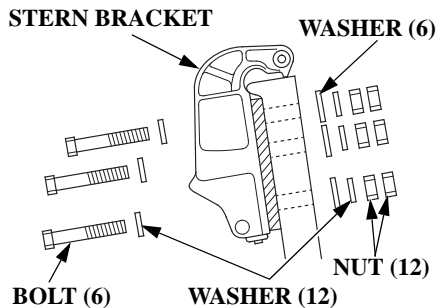

1. Apply the silicone sealant (Three Bond 1216 or equivalent) to the outboard motor mounting holes.
2. Set the outboard motor on the boat and secure with the bolts, washers, and lock nuts.

NOTE:

Standard torque:

55 N·m (5.6 kgf·m, 41 lbf·ft)

The standard torque is given just as a guideline. Torque of the nut can be different according to the material of the boat. Consult with an authorized TOHATSU outboard motor dealer.

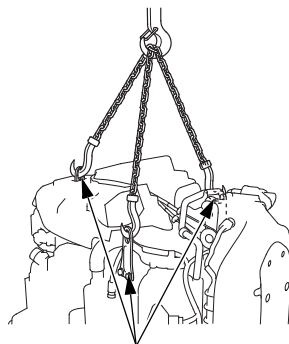

LIFTING EYES

▲ CAUTION

Install the outboard motor securely. Loosely mounted outboard motor can result in accidental loss of the outboard motor and damage and injury to the equipment and personnel.

Before installing the outboard motor on the boat, hang the outboard motor with the hoist or equivalent device by attaching the three lifting eyes to the outboard.

Use the hoist which allowable load is 300 kg (661 lbs) or above.

Outboard Motor Angle Inspection (Cruising)

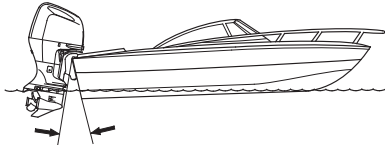

**INCORRECT
CAUSES BOAT TO "SQUAT"**

Install the outboard motor at the best trim angle for stable cruising and maximum power.

Trim angle too large: Incorrect causes boat to "squat."

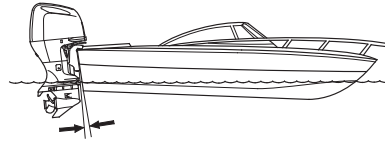

**INCORRECT
CAUSES BOAT TO "PLOW"**

Trim angle too small: Incorrect causes boat to "plow."

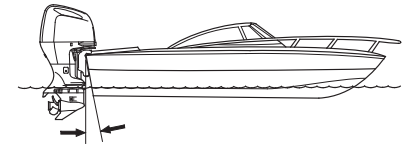

**CORRECT
GIVES MAXIMUM PERFORMANCE**

The trim angle differs according to the combination of the boat, outboard motor, and propeller, and the operating conditions.

Adjust the outboard motor so that it is perpendicular to the water surface (i.e. axis of the propeller is parallel with the water surface).

INSTALLATION

Battery Connections

Use a battery which has CCA (COLD CRANKING AMPERES) 799A at -18°C (0°F) and a reserve capacity 229 minutes (12V-110Ah/20HR) or more specifications.

The battery is an optional part (i.e. part to be purchased separately from the outboard motor).

▲WARNING

Batteries produce explosive gases: If ignited, an explosion can cause serious injury or blindness. Provide adequate ventilation when charging.

- **CHEMICAL HAZARD:** Battery electrolyte contains sulfuric acid. Contact with eyes or skin, even through clothing, may cause severe burns. Wear a faceshield and protective clothing.
- **Keep flames and sparks away, and do not smoke in the area.**
ANTIDOTE: If electrolyte gets into your eyes, flush thoroughly with warm water for at least 15 minutes and call a physician immediately.

- **POISON:** Electrolyte is poison.
ANTIDOTE:
 - **External:** Flush thoroughly with water.
 - **Internal:** Drink large quantities of water or milk. Follow with milk of magnesia or vegetable oil, and call a physician immediately.
- **KEEP OUT OF REACH OF CHILDREN.**

To protect the battery from mechanical damage and to prevent the battery from falling or tipping over, the battery must be:

- Installed in the correct size corrosion-resistant battery box.
- Properly secured in the boat.
- Secured in a location free from direct sunlight and water spray.
- Secured away from the fuel tank to avoid potential sparks near the fuel tank.

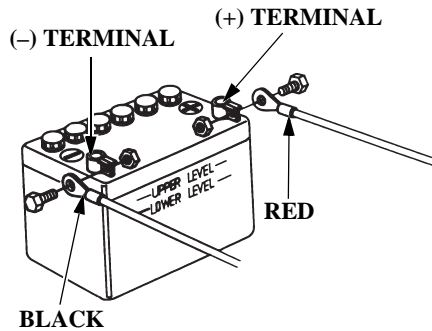

Connect the battery cables:

1. Connect the cable with the red terminal cover to the positive (+) terminal of the battery.
2. Connect the cable with the black terminal cover to the negative (-) terminal of the battery.

NOTE:

When more than one outboard motor is mounted on a boat, connect a battery to each respective outboard motors.

NOTICE

- **Be sure to connect the (+) side battery cable first. When disconnecting the cables, disconnect the (-) side first then the (+) side.**
 - **Unless the cables are properly connected to the terminals, the starter motor may fail to operate normally.**
 - **Be careful to avoid connecting the battery in reverse polarity, as this will damage the battery-charging system in the outboard motor.**
 - **Do not disconnect the battery cables while the engine is running. Disconnecting the cables while the engine is running, will damage the outboard motor's electrical system.**
 - **Do not place the fuel tank near the battery.**
- **Battery cable extension:**
Extending the original battery cable will cause the battery voltage to drop due to the increased length of the cable and number of connections. This voltage drop may cause the buzzer to sound momentarily when engaging the starter motor and may prevent the outboard from starting. If the outboard starts and the buzzer sounds momentarily, there may be barely sufficient voltage reaching the engine.

INSTALLATION

Remote Control Installation (optional equipment)

NOTICE

Improperly installed steering system, remote control box, and remote control cable, or installing those of the different types could cause unpredictable accident. Consult an authorized TOHATSU outboard motor dealer for proper installation.

The control box is available in three types as shown. Select the most suitable control box for your outboard motor considering the installation position, operationability, etc. of the control box. See an authorized TOHATSU outboard motor dealer for further information.

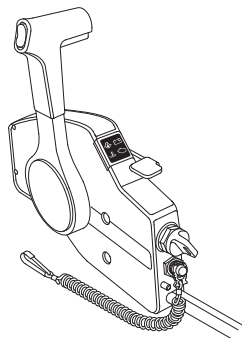

**SIDE-MOUNT
TYPE CONTROL BOX**

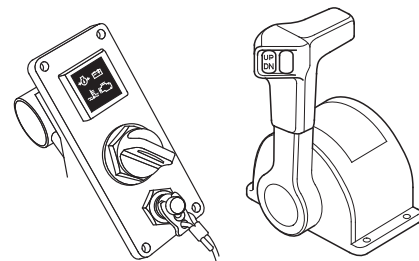

**TOP-MOUNT TYPE CONTROL BOX
(FOR SINGLE OUTBOARD MOTOR TYPE)
AND SWITCH PANEL**

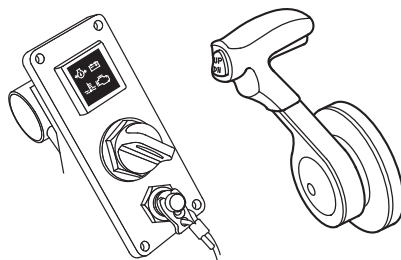

**PANEL-MOUNT TYPE CONTROL
BOX AND SWITCH PANEL**

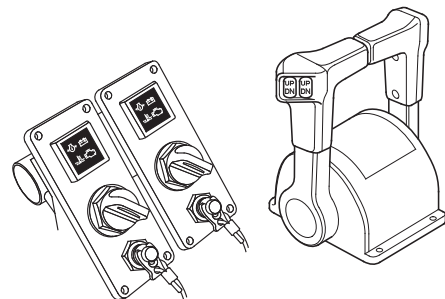

**TOP-MOUNT TYPE CONTROL BOX AND
SWITCH PANEL
(FOR DUAL OUTBOARD MOTOR TYPE)**

<Remote Control Box Location>

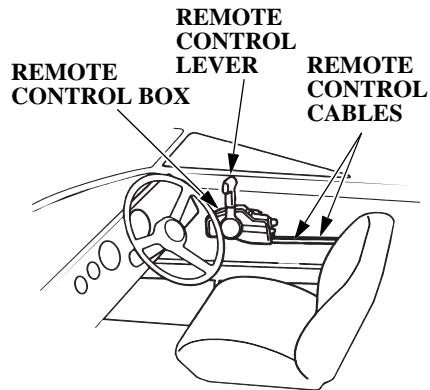

Install the remote control box in the position where is easy to operate the remote control lever and switches. Be sure that there are no obstacles on the route of the control cable.

The control box position of the R2 type and the R3 type should be determined in the same manner.

<Remote Control Cable Length>

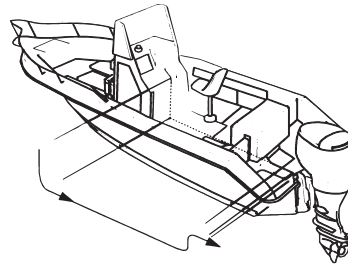

Measure the distance from the control box to the outboard motor along the cable routing.

Recommended cable length is 300 – 450 mm (11.8 – 17.7 in) longer than the measured distance.

Set the cable along the predetermined route and be sure that it is long enough to the route.

Connect the cable to the engine and be sure it is not kinked, bent sharp, pulled taut, or interfered while steering.

NOTICE

Do not bend the remote control cable as sharp as its route diameter is 300 mm (11.8 in) or less, or it affects the service life of the cable and the remote control lever operation.

INSTALLATION

Propeller Selection

Select the adequate propeller so that the engine speed at full throttle is $5,300 \text{ min}^{-1}$ (rpm) to $6,300 \text{ min}^{-1}$ (rpm) when the boat is loaded.

Engine speed varies according to the propeller size and the boat condition. Use of the outboard motor outside the full throttle speed range will adversely affect the engine and cause serious problem. Use of the correct propeller assures powerful acceleration, top speed, excellency in terms of economy and cruising comfort, and it assures longer engine life as well.

Consult with your authorized TOHATSU outboard motor dealer for proper propeller selection.

Fuel Line Connection

Connect the fuel line to the tank and the outboard motor. Follow the boat manufacturer's instructions.

▲WARNING

Gasoline is extremely flammable, and gasoline vapor can explode, causing serious injury or death.

- **Be careful not to spill fuel. Spilled fuel or fuel vapor may ignite. If any fuel is spilled, make sure the area is dry before storing or transporting the outboard motor.**
- **Do not smoke or allow flames or sparks where fuel is drained or stored.**

6. PRE-OPERATION CHECKS

BFT250A is 4-stroke, water cooled outboard motor which uses unleaded regular gasoline for fuel. It also requires the engine oil. Check the following before operating the outboard motor.

▲ CAUTION

Perform the following pre-operation checks with the engine stopped.

Before each use, look around and underneath the engine for signs of oil or gasoline leaks.

Engine Cover Removal/Installation

<Removal>

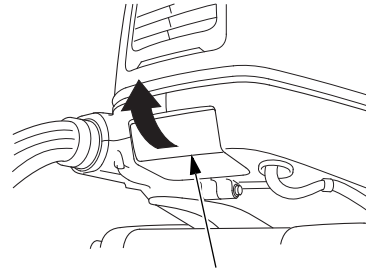

ENGINE COVER LATCH

1. Pull the engine cover latch.
2. Remove the engine cover by taking it up.

<Installation>

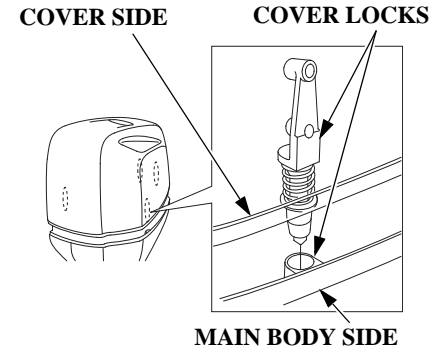

1. Place the engine cover on the main body.
2. Slide the engine cover so that the cover lock on the cover is mated with the lock in the main body.

PRE-OPERATION CHECKS

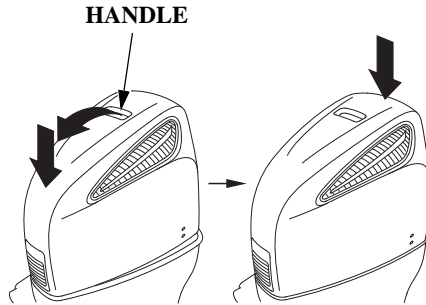

3. While pulling the handle on the engine cover toward you, push the front end of the engine cover until you hear click.
4. Also, push the rear end until you hear click.

▲WARNING

Do not operate the outboard motor without the engine cover. Exposed moving parts can cause injury.

Engine Oil

NOTICE

- **Engine oil is a major factor affecting engine performance and service life. Nondetergent and low quality oils are not recommended, because they have inadequate lubricating properties.**
- **Running the engine with insufficient oil can cause serious engine damage.**

<Recommended oil>

Use 4-stroke high detergent, premium quality outboard motor oil certified to meet or exceed U.S. automobile manufacturer's requirements for Service category SG, SH or SJ. Outboard motor oils category SG, SH or SJ will show this designation on the container.

SAE 10W-30 is recommended for general use.

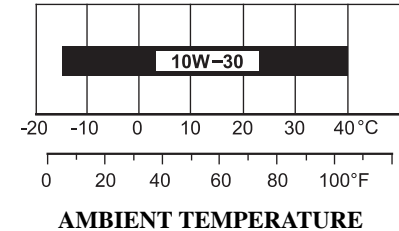

<Inspection and Refilling>

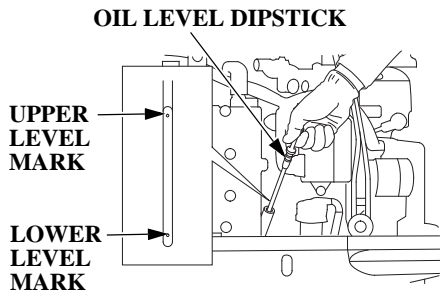

1. Position the outboard motor vertically, and remove the engine cover (see page 39).
2. Remove the oil level dipstick and wipe with a clean rag.
3. Reinsert the dipstick all the way in, then pull it out and read the level. If near or below the lower level mark, remove the oil filler cap and fill to the upper level mark with the recommended oil. Tighten the oil filler cap securely. Do not overtighten.

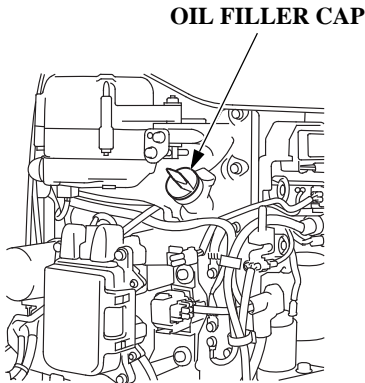

- When the engine oil is contaminated or discolored, replace with the fresh engine oil (see page 84 for replacement interval and procedure).
4. Install the engine cover and lock it securely (see page 39).

NOTICE

**Do not overfill the engine oil.
Check the engine oil after refilling.
Excessive engine oil as well as the
insufficient oil could cause damage
to the engine.**

PRE-OPERATION CHECKS

When you check the oil level with the dipstick, you might notice the engine oil appears milky or the oil level has increased. If you notice either condition, change the engine oil. See the following table for an explanation of these conditions.

Operating Method	Result	Effect
Running the engine below 3,000 rpm for more than 30% of the time so the engine does not warm up.	<ul style="list-style-type: none">• Water condenses in the engine and mixes with the oil, resulting in a milky appearance.	The engine oil deteriorates, becomes less efficient as a lubricant, and causes an engine malfunction.
Frequent starting and stopping without allowing the engine to warm up.	<ul style="list-style-type: none">• Unburned fuel mixes with the oil, increasing the volume of oil.	

Fuel

Check the fuel level and refill if necessary. Do not fill the fuel tank above the UPPER LIMIT.

Refer to the boat manufacturer's instructions.

Use unleaded gasoline with a Research Octane Number of 91 or higher (a Pump Octane Number of 86 or higher). Use of leaded gasoline may cause damage to the engine.

Never use an oil/gasoline mixture or dirty gasoline. Avoid getting dirt, dust or water in the fuel tank.

▲WARNING

Gasoline is extremely flammable and is explosive under certain conditions.

- **Refuel in a well-ventilated area with the engine stopped.**
 - **Do not smoke or allow flames or sparks in the area where the engine is refueled or where gasoline is stored.**
 - **Do not overfill the fuel tank (there should be no fuel in the filler neck). After refueling, make sure the tank cap is closed properly and securely.**
 - **Be careful not to spill fuel when refueling. Spilled fuel or fuel vapor may ignite. If any fuel is spilled, make sure the area is dry before starting the engine.**
 - **Avoid repeated or prolonged contact with skin or breathing of vapor.**
- KEEP OUT OF REACH OF CHILDREN.**

GASOLINE CONTAINING ALCOHOL

If you decide to use a gasoline containing alcohol (gasohol), be sure its octane rating is at least as high as that recommended by TOHATSU. There are two types of “gasohol”: one containing ethanol, and the other containing methanol. Do not use gasohol that contains more than 10% ethanol. Do not use gasoline containing more than 5% methanol (methyl or wood alcohol) and that does not also contain co-solvents and corrosion inhibitors for methanol.

NOTE:

- Fuel system damage or engine performance problems resulting from the use of gasoline that contains more alcohol than recommended is not covered under the warranty.
- Before buying gasoline from an unfamiliar station, first determine if the gasoline contains alcohol, if it does, find out the type and percentage of alcohol used. If you notice any undesirable operating symptoms while using a particular gasoline. Switch to a gasoline that you know contains less than the recommended amount of alcohol.

PRE-OPERATION CHECKS

Propeller and Cotter Pin Inspection

▲WARNING

The propeller blades are thin and sharp. Careless handling of the propeller can result in injury. When checking the propeller:

- Remove the emergency stop switch clip to prevent an accidental start of the engine.
- Wear heavy gloves.

Propeller rotates rapidly while cruising. Before starting the engine, check the propeller blades for damage and deformation and replace if necessary.

Obtain a spare propeller for the event of an unpredictable accident while cruising. If no spare propeller is available, return to the pier at low speed and replace.

Consult an authorized TOHATSU outboard motor dealer for propeller selection.

Keep the spare washer, castle nut and cotter pin with you on your boat.

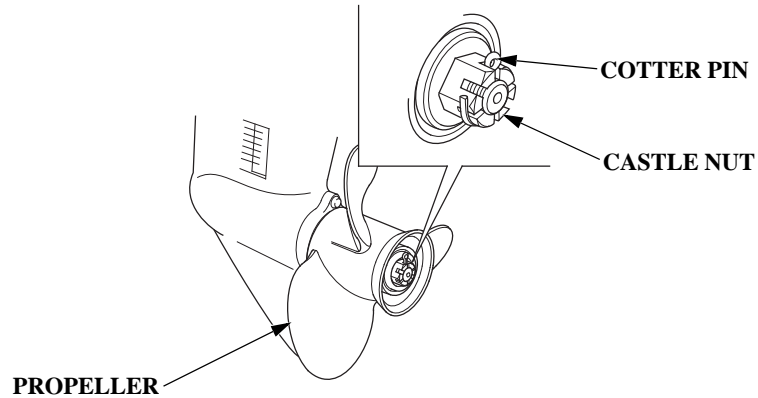

Engine speed varies according to the propeller size and the boat condition. Use of the outboard motor outside the full throttle speed range will adversely affect the engine and cause a serious problem. Use of the correct propeller assures powerful acceleration, top speed, excellency in terms of economy and cruising comfort, and it assures longer engine life as well.

Consult with your authorized TOHATSU outboard motor dealer for proper propeller selection.

1. Check the propeller for damage, wear, or deformation.
2. Check whether the propeller is installed properly.
3. Check the cotter pin for damage. Replace whenever the propeller is faulty.

PRE-OPERATION CHECKS

Remote Control Lever Friction

(R1 type)

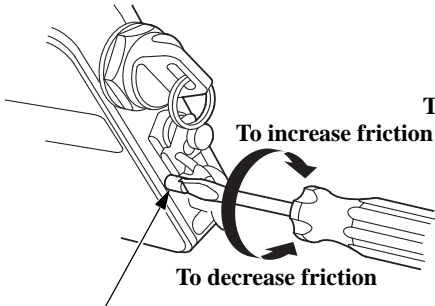

CONTROL LEVER FRICTION ADJUSTER

Check whether the remote control lever moves smoothly. Friction of the lever can be adjusted by turning the control lever friction screw right or left.

(R2 type)

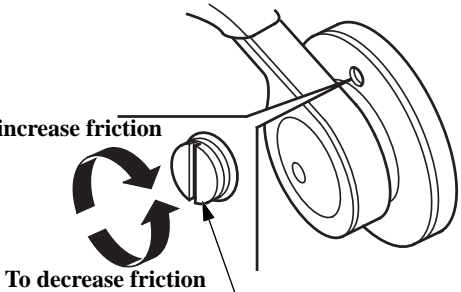

CONTROL LEVER FRICTION ADJUSTER

(R3 type)

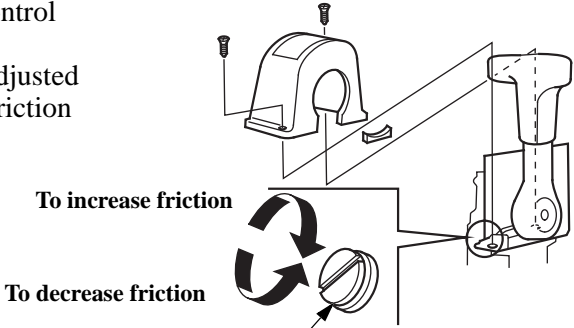

CONTROL LEVER FRICTION ADJUSTER

Fuel Filter

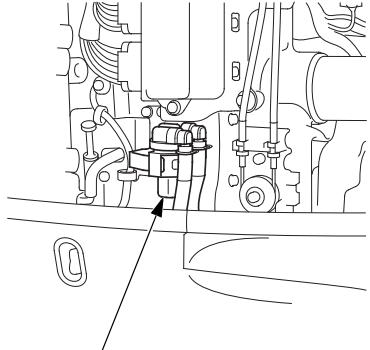

FUEL FILTER (inside strainer cup)

Fuel filter is located beside the oil level dipstick. Check the fuel filter for water accumulation. If water is accumulated, drain them (see page 92).

PRE-OPERATION CHECKS

Battery

NOTICE

Battery handling differs according to the type of the battery and the instructions described below might not be applicable to the battery of your outboard. Refer to the battery manufacturer's instructions.

Battery Inspection

Check whether the battery fluid is between the upper and lower levels, and check the vent hole in the battery caps for clogging.

If the battery fluid is near or below the lower level, add the distilled water to the upper level (see page 98).

Check that the battery cables are connected securely. If the battery terminals are contaminated or corroded, remove the battery and clean the terminals (see page 99).

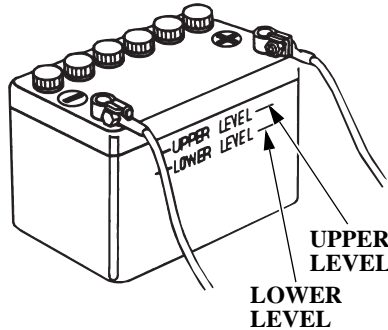

▲WARNING

Batteries produce explosive gases: If ignited, an explosion can cause serious injury or blindness. Provide adequate ventilation when charging.

- **CHEMICAL HAZARD:** Battery electrolyte contains sulfuric acid. Contact with eyes or skin, even through clothing, may cause severe burns. Wear a faceshield and protective clothing.

- Keep flames and sparks away, and do not smoke in the area.
ANTIDOTE: If electrolyte gets into your eyes, flush thoroughly with warm water for at least 15 minutes and call a physician immediately.
- **POISON:** Electrolyte is poison.
ANTIDOTE:
 - External: Flush thoroughly with water.
 - Internal: Drink large quantities of water or milk. Follow with milk of magnesia or vegetable oil, and call a physician immediately.
- **KEEP OUT OF REACH OF CHILDREN.**

PRE-OPERATION CHECKS

Other Checks

(5) TOOL KIT (see page 81)

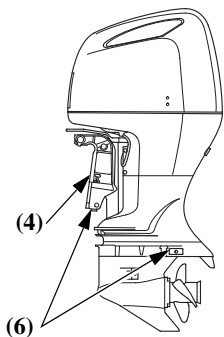
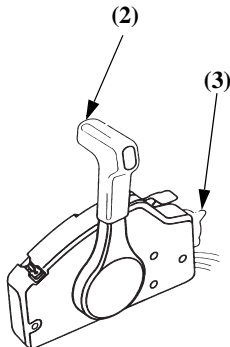
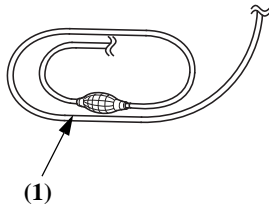

Check the following items:

- (1) The fuel hose for kinking, collapsing or a loose connection.
- (2) The control lever for smooth operation.
- (3) The switch for correct operation.
- (4) The stern bracket for damage.
- (5) The tool kit for missing spare parts and tools (see page 81).
- (6) The anode metal for damage, looseness or excessive corrosion.

The anode (sacrificed metal) helps to protect the outboard motor from corrosion damage; it must be exposed directly to the water whenever the outboard motor is in use. Replace the anodes when they have been reduced to about two-thirds of their original size, or if they are crumbling.

NOTICE

The possibility of corrosion damage is increased if the anode is painted over or allowed to deteriorate.

Parts/materials which should be installed on board:

- Owner's Manual
- Tool kit
- Spare parts: spark plugs, engine oil, spare propeller, castle nut, washer, cotter pin.
- Spare emergency stop switch clip.
- Other parts/materials required by laws/regulations.

7. STARTING THE ENGINE

Fuel Priming

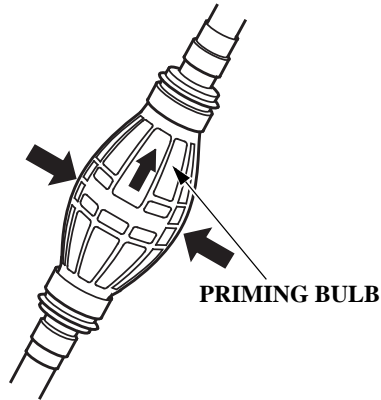

Hold the priming bulb so that the outlet end is higher than the inlet (so that the arrow on the priming bulb points up), and squeeze it until it feels firm, indicating that fuel has reached the outboard motor. Check for leaks.

▲WARNING

Be careful not to spill any fuel. Spilled fuel vapor may ignite. If any fuel is spilled, make sure the area is dry before starting the engine.

NOTICE

Do not touch the priming bulb with the engine running or when tilting up the outboard motor. The vapor separator could overflow.

Starting the Engine (R1 type)

EMERGENCY STOP SWITCH

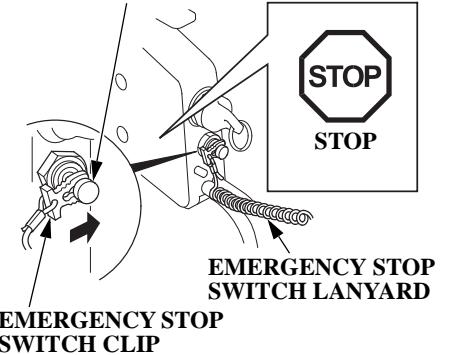

▲WARNING

The exhaust contains poisonous carbon monoxide. Do not start the engine in a poor ventilation area such as in a boat house.

NOTICE

To prevent damage to the outboard from overheating, never run the engine with the propeller out of water.

STARTING THE ENGINE

1. Insert the emergency stop switch clip at one end of the emergency stop switch lanyard into the emergency stop switch. Attach the other end of the lanyard securely to the operator.

▲WARNING

If the operator does not attach the emergency stop switch lanyard, and is thrown from his seat or out of the boat, the out-of-control boat can seriously injure the operator, passengers, or bystanders. Always properly attach the lanyard before starting the engine.

NOTE:

The engine will not start unless the emergency stop switch clip is engaged with the emergency stop switch.

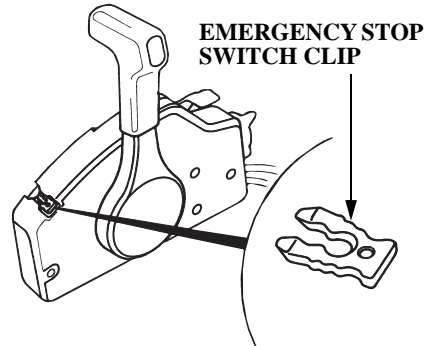

A spare emergency stop switch clip is provided near the indicator light.

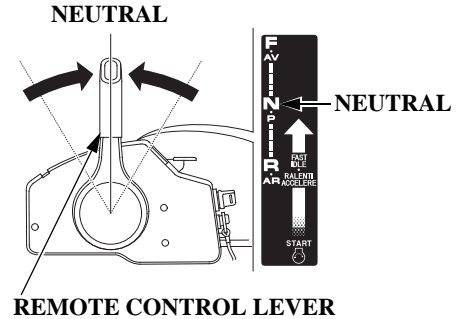

2. Set the control lever in the NEUTRAL position. The engine does not start unless the control lever is set in the NEUTRAL position.

STARTING THE ENGINE

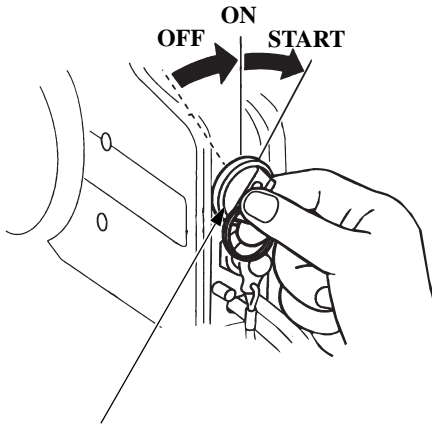

ENGINE SWITCH KEY

3. Turn the engine switch key to the START position and hold it there until the engine starts. When the engine starts, release the key, allowing it to return to the ON position.

NOTICE

- The starter motor consumes a large amount of current. Do not therefore run it continuously for more than 5 seconds at a time. If the engine does not start within 5 seconds, wait at least 10 seconds before running the starter motor again.
- Do not turn the engine switch key to the START position while the engine is running.

COOLING WATER CHECK HOLE

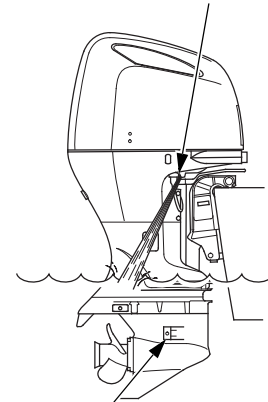

COOLING WATER INTAKE PORT
(each side)

4. After starting, check whether the cooling water is flowing out of the cooling water check hole. Amount of water flowing out of the check hole might vary due to the thermostat operation, but this is normal.

STARTING THE ENGINE

NOTICE

If water does not flow out, or if steam comes out, stop the engine. Check to see if the screen in the cooling water intake port is obstructed and remove foreign materials if necessary. Check the cooling water check hole for clogging. If water still does not flow out, have your outboard motor checked by an authorized TOHATSU outboard motor dealer. Do not operate the engine until the problem has been corrected.

5. Check to see if the oil pressure indicator turns ON.

If it does not turn on, stop the engine and perform the following inspections.

- 1) Check the oil level (see page 42).
- 2) If the oil level is normal and the oil pressure indicator does not turn ON, consult with an authorized TOHATSU outboard motor dealer.

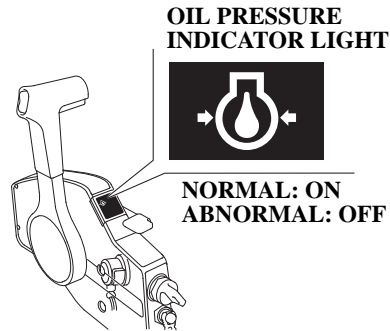

6. Warm up the engine as follows:
- Above 5°C (41°F) – run the engine for 2 or 3 minutes.
 - Below 5°C (41°F) – run the engine for at least 5 minutes at 2,000 min⁻¹ (rpm).
- Failure to completely warm up the engine will result in poor engine performance.

NOTICE

If the engine is not properly warmed-up before raising the engine speed, the warning buzzer and overheat indicator may activate and the engine speed will be automatically reduced.

NOTE:

Before leaving the dock, check the operation of the emergency stop switch.

STARTING THE ENGINE

(R2, R3 types)

EMERGENCY STOP SWITCH

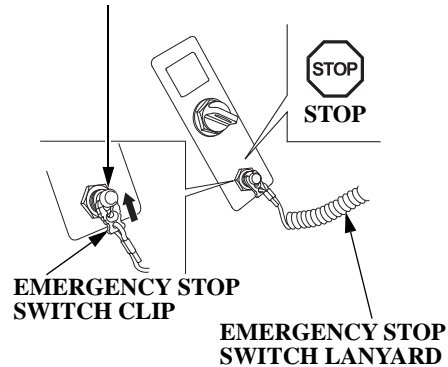

▲WARNING

The exhaust contains poisonous carbon monoxide. Do not start the engine in a poor ventilation area such as in a boat house.

NOTICE

To prevent damage to the outboard from overheating, never run the engine with the propeller out of water.

NOTE:

When the boat is mounted with the two outboard motors, perform the following on the right and left engines respectively.

1. Insert the emergency stop switch clip at one end of the emergency stop switch lanyard into the emergency stop switch. Attach the other end of the lanyard securely to the operator.

▲WARNING

If the operator does not attach the emergency stop switch lanyard, and is thrown from his seat or out of the boat, the out-of-control boat can seriously injure the operator, passengers, or bystanders. Always properly attach the lanyard before starting the engine.

NOTE:

The engine does not start unless the emergency stop switch clip is set on the emergency stop switch.

SPARE EMERGENCY STOP SWITCH CLIP (optional equipment)

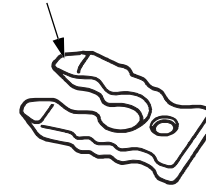

A spare emergency stop switch clip (optional equipment) can be stored in the tool bag.

STARTING THE ENGINE

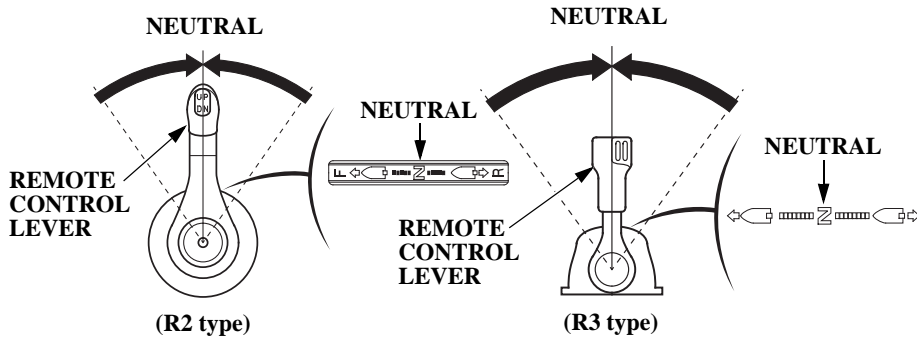

2. Set the control lever in the NEUTRAL position.
The engine does not start unless the control lever is set in the NEUTRAL position.

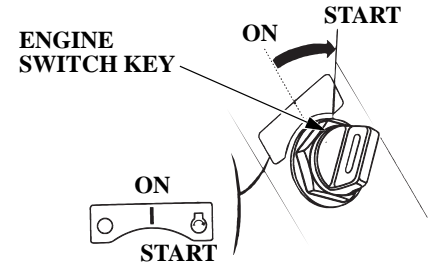

3. Turn the engine switch key to the START position and hold it there until the engine starts.
When the engine starts, release the key, allowing it to return to the ON position.

NOTICE

- The starter motor consumes a large amount of current. Do not therefore run it continuously for more than 5 seconds at a time. If the engine does not start within 5 seconds, wait at least 10 seconds before running the starter motor again.
- Do not turn the engine switch key to the START position while the engine is running.

STARTING THE ENGINE

NOTE:

When the boat is mounted with the two outboard motors, perform the above procedure on the right and left outboard motors respectively.

COOLING WATER CHECK HOLE

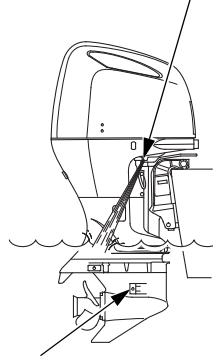

COOLING WATER INTAKE PORT (each side)

4. After starting, check whether the cooling water is flowing out of the cooling water check hole. Amount of water flowing out of the check hole might vary due to the thermostat operation, but this is normal.

NOTICE

If water does not flow out, or if steam comes out, stop the engine. Check to see if the screen in the cooling water intake port is obstructed and remove foreign materials if necessary. Check the cooling water check hole for clogging. If water still does not flow out, have your outboard motor checked by an authorized TOHATSU outboard motor dealer. Do not operate the engine until the problem has been corrected.

ENGINE OIL PRESSURE INDICATOR

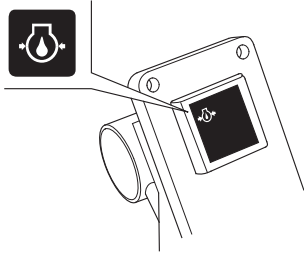

NORMAL: ON
ABNORMAL: OFF

5. Check to see if the oil pressure indicator turns ON.

If it does not turn on, stop the engine and perform the following inspections.

- 1) Check the oil level (see page 42).
- 2) If the oil level is normal and the oil pressure indicator does not turn ON, consult with an authorized TOHATSU outboard motor dealer.

6. Warm up the engine as follows:
Above 5°C (41°F) – run the engine for 2 or 3 minutes.
Below 5°C (41°F) – run the engine for at least 5 minutes at 2,000 min⁻¹ (rpm).
Failure to completely warm up the engine will result in poor engine performance.

NOTICE

If the engine is not properly warmed-up before raising the engine speed, the warning buzzer and overheat indicator may activate and the engine speed will be automatically reduced.

NOTE:

Before leaving the dock, check the operation of the emergency stop switch.

8. OPERATION

Break-in Procedure

Break-in period: 10 hours

Break-in operation allows the mating surfaces of the moving parts to wear evenly and thus ensures proper performance and longer outboard motor life.

Break-in your new outboard motor as follows.

First 15 minutes:

Run the outboard motor at trolling speed. Use the minimum amount of throttle opening necessary to operate the boat at a safe trolling speed.

Next 45 minutes:

Run the outboard motor up to a maximum of 2,000 to 3,000 min^{-1} (rpm) or 10% to 30% throttle opening.

Next 60 minutes:

Run the outboard motor up to maximum of 4,000 to 5,000 min^{-1} (rpm) or 50% to 80% throttle opening. Short bursts of full throttle are acceptable but do not operate the outboard motor continuously at full throttle.

Next 8 hours:

Avoid continuous full throttle operation (100% throttle opening). Do not run the outboard motor at full throttle for more than 5 minutes at a time.

For boats that plane easily, bring the boat up on plane then reduce the throttle opening to the specified break-in settings called out above.

Gear Shifting

(R1 type) NEUTRAL RELEASE LEVER

REMOTE CONTROL LEVER

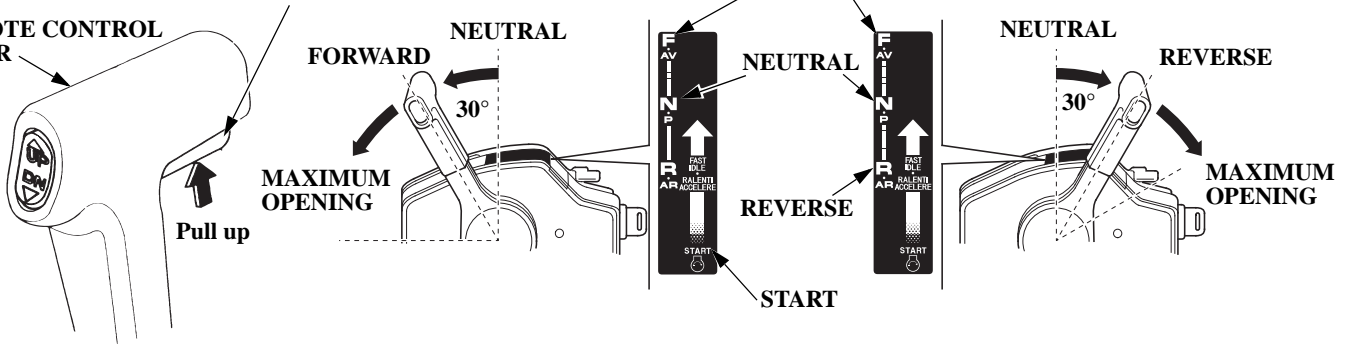

⚠ CAUTION

Avoid sharp and abrupt operation of the control lever. Operate it moderately. Operate the control lever and raise the engine speed after making sure that the gear was shifted securely.

While pulling the neutral release lever, move the control lever approximately 30° toward the FORWARD or REVERSE position to engage the desired gear.

Moving the control lever further from approximately 30° will increase throttle opening and boat speed.

The control lever will not move unless the neutral release lever is pulled up.

OPERATION

Gear Shifting (R2 type)

REMOTE CONTROL LEVER

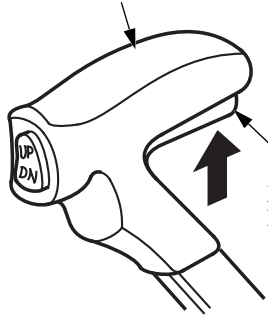

NEUTRAL RELEASE
LEVER

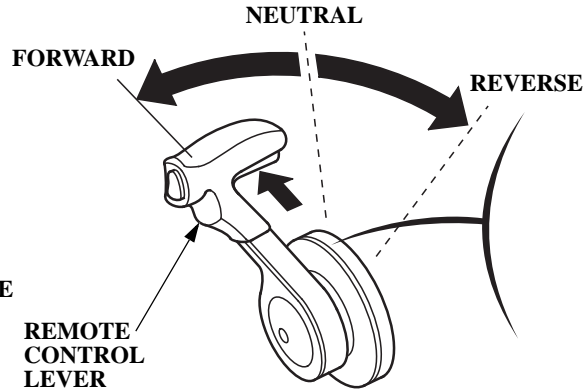

REMOTE
CONTROL
LEVER

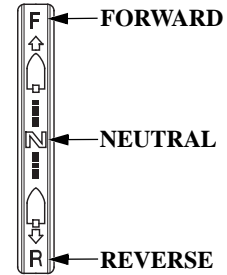

⚠ CAUTION

Avoid sharp and abrupt operation of the control lever. Operate it moderately. Operate the control lever and raise the engine speed after making sure that the gear was shifted securely.

While pulling the neutral release lever, move the control lever approximately 35° toward the FORWARD or REVERSE position to engage the desired gear.

Moving the control lever further from approximately 35° will increase throttle opening and boat speed.

The control lever will not move unless the neutral release lever is pulled up.

Gear Shifting (R3 type)

SINGLE TYPE

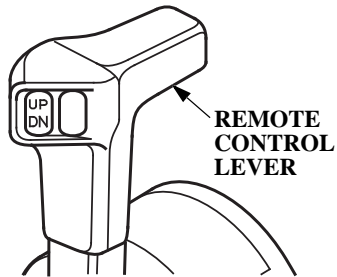

DUAL TYPE

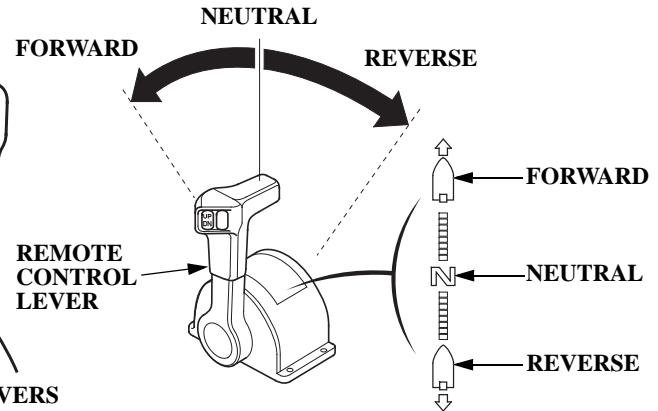
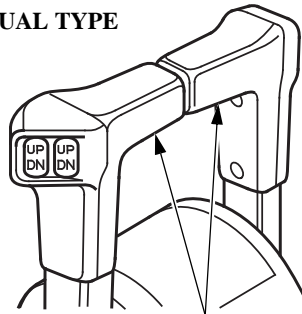

⚠ CAUTION

Avoid sharp and abrupt operation of the control lever. Operate it moderately. Operate the control lever and raise the engine speed after making sure that the gear was shifted securely.

Move the control lever(s) approximately 35° toward the FORWARD or REVERSE position to engage the desired gear.

When the boat is mounted with the two outboard motors, hold the control lever in the center as shown, and operate the right and left levers simultaneously.

Moving the control lever(s) further from approximately 35° will increase throttle opening and boat speed.

OPERATION

Cruising

(R1 type)
POWER TRIM/
TILT SWITCH

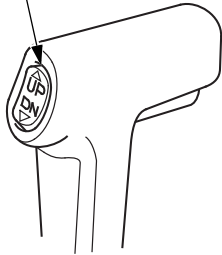

(R2 type)
POWER TRIM/
TILT SWITCH

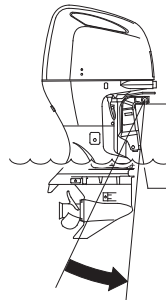
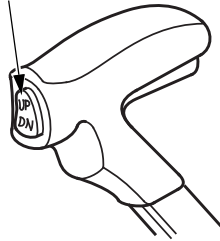

LOWERMOST
POSITION

(R3 type)
(single type)
POWER TRIM/
TILT SWITCH

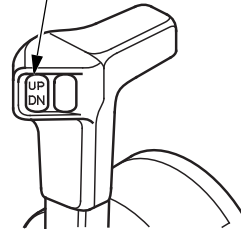

(dual type)
POWER TRIM/TILT SWITCH
(LEFT) (RIGHT)

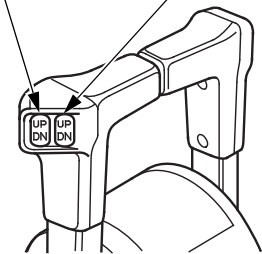

1. Press on the DN (down) of the power trim/tilt switch and trim the outboard motor at the lowermost position.

R3 type:

When the two outboard motors are mounted:

1) Press on the DN (down) of the power trim/tilt switch on the remote control lever and trim the outboard motors at the lowermost position.

2) With the outboard motors trimmed at the lowermost position, adjust the trim angle of the right and left outboard motors using the switch on the remote control lever simultaneously.

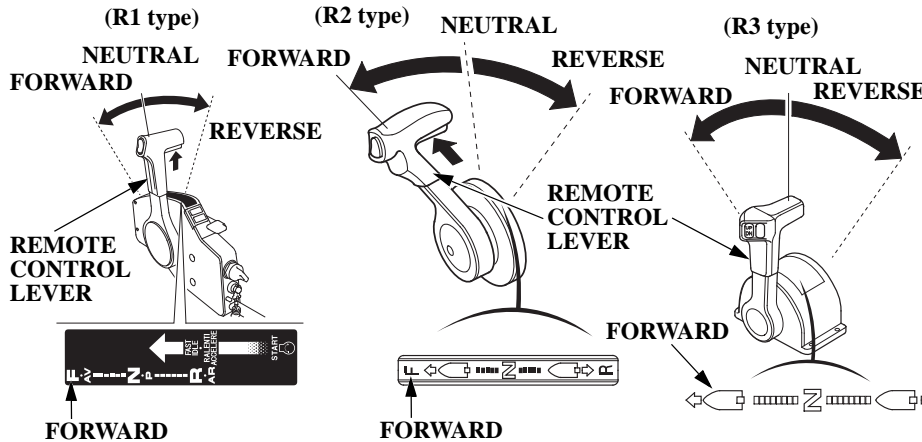

2. Move the control lever from NEUTRAL toward FORWARD position.

R1 type:
Moving about 30° engages the gear. Moving the control lever further opens the throttle and increases the engine speed.

R2, R3 type:
Moving about 35° engages the gear. Moving the control lever further opens the throttle and increase the boat speed.

For the sake of fuel economy, open the throttle about 80%.

NOTE:

- When cruising at full throttle, note that the engine speed must be in the range between 5,300 min⁻¹ (rpm) and 6,300 min⁻¹ (rpm).
- If you feel that the engine speed jumped up when the hull jumped or at ventilation, cruise the boat by returning the throttle to the slow speed side.
- See “Propeller Selection” (see page 38) for a relation between the propeller and the engine speed.

CAUTION

Do not operate without the engine cover. Exposed moving parts could cause injury; water may damage the engine.

NOTE:

For best performance, passengers and equipment should be distributed evenly to balance the boat.

OPERATION

Trimming the Outboard Motor

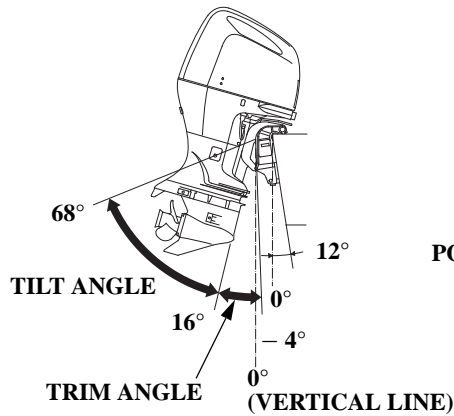

(when transom angle is 12°)

The BFT250A is equipped with the power trim/tilt system which can adjust the outboard motor angle (trim/tilt angle) while cruising and mooring. The outboard motor angle can also be adjusted while cruising and accelerating to obtain the maximum speed and optimum driveability and fuel economy.

POWER TRIM/TILT SWITCH (R1 type)

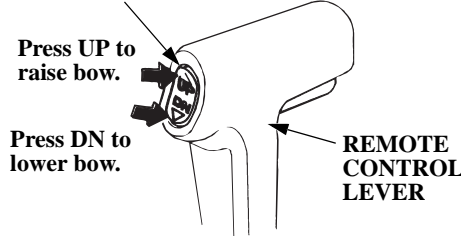

POWER TRIM/TILT SWITCH (R2 type)

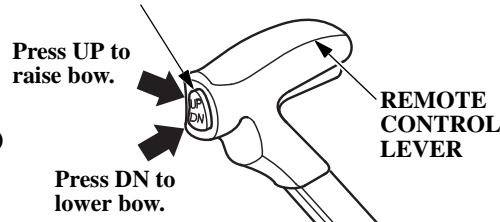

Press either UP or DN (down) of the power trim/tilt switch and tilt the outboard motor to the best position in compliance with the cruising conditions.

POWER TRIM/TILT SWITCH (R3 type) Single Type

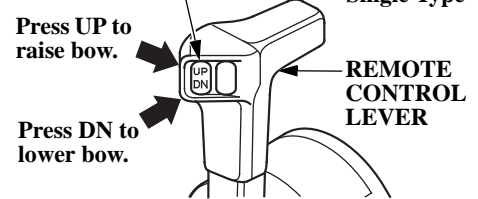

POWER TRIM/TILT SWITCH (LEFT) (RIGHT) (R3 type) Dual Type

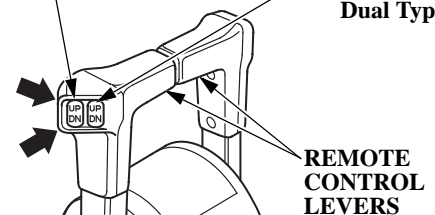

The power trim/tilt system operates when the switch is pressed, and it stops when the switch is released. To trim up slightly, press on UP momentarily but securely. To trim down slightly, press on DN (down) in the same manner.

⚠ CAUTION

- Improper trim angle results in unstable steering condition.
- Do not trim excessively while cruising through rough waves, or it may cause an accident.
- Excessive trim angle can result in cavitation and racing of the propeller, and trimming up the outboard motor excessively can cause damage to the impeller pump.

NOTE:

- Decrease the trim angle on high speed turns to reduce the possibility of propeller ventilation.
- Improper outboard motor trim angle can result in an unstable steering condition.

OUTBOARD MOTOR TRIMMED TOO LOW

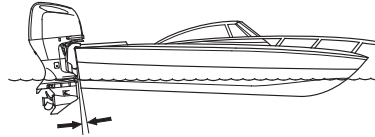

OUTBOARD MOTOR TRIMMED TOO HIGH

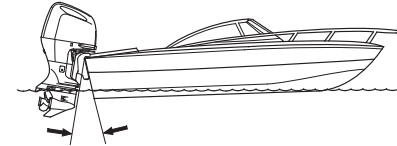

OUTBOARD MOTOR TRIMMED CORRECTLY

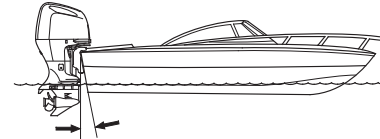

When cruising:

- (A) Into a high wind, trim the outboard motor down slightly to lower the bow and improve boat stability.
- (B) With a tail wind, trim the outboard motor up slightly to raise the bow and improve boat stability.
- (C) Through rough waves, do not trim the outboard motor too low or too high to avoid an unstable steering condition.

OPERATION

Trim Meter (optional equipment)

The trim meter indicates the trim angle of the outboard motor. Refer to the trim meter, and press the UP or DN (down) portion of the power trim/tilt switch to adjust the outboard motor trim angle to achieve boat performance and stability.

The illustration represents R1 type. Perform the same procedure for the other types.

▲WARNING

When the boat is mounted with the two outboard motors, adjust with the switch on the control lever side. Adjustment with the switch on the console side will impair the balance between the right and left outboard motors, which adversely affects operationability and stability of the outboard motors.

- BOW TOO LOW DUE TO**
1. LOAD IN THE FRONT
2. OUTBOARD MOTOR TRIMMED TOO LOW

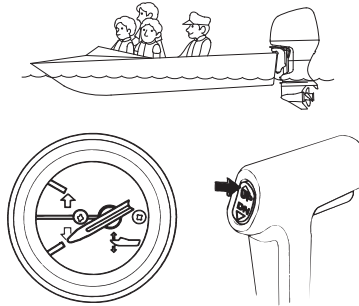

With the outboard motor trimmed low the trim meter will read as shown. To raise the bow increase the outboard motor trim angle by pressing the UP portion of the power trim/tilt switch.

- BOW TOO HIGH DUE TO**
1. LOAD IN THE REAR
2. OUTBOARD MOTOR TRIMMED TOO HIGH

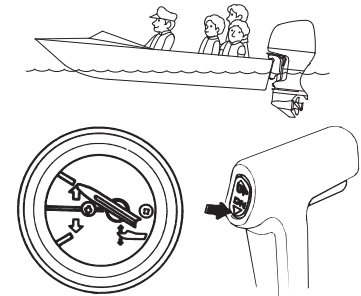

With the outboard motor trimmed high the trim meter will read as shown. To lower the bow decrease the outboard motor trim angle by pressing the DN (down) portion of the power trim/tilt switch.

Tilting the Outboard Motor

Tilt the outboard motor to prevent the propeller and gear case from hitting the bottom when the boat is beached or stopped in shallow water. Please tilt up simultaneously, when you mount the dual type outboard motor.

1. Move the shift lever or the control lever to the NEUTRAL position and stop the engine.
2. Press the UP of the power trim/tilt switch and tilt the outboard motor to the best position in compliance.

(R1 type)
POWER TRIM/TILT SWITCH

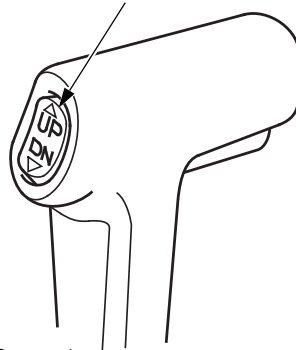

(R2 type)
POWER TRIM/TILT SWITCH

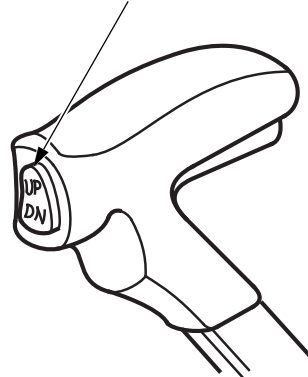

(R3 type)
(single type)

POWER TRIM/TILT SWITCH

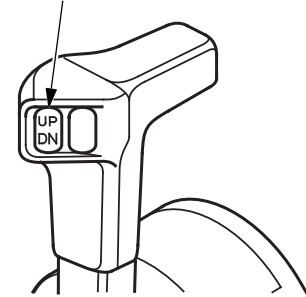

(R3 type)
(dual type)

POWER TRIM/TILT SWITCH
(LEFT) (RIGHT)

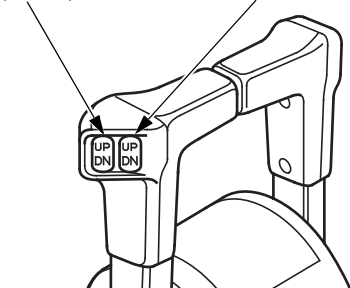

OPERATION

Moorage

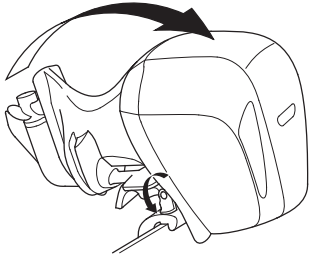

Tilt up the outboard motor using the tilt lock lever when mooring the boat. Shift the control lever into the NEUTRAL position and stop the engine before tilting up the outboard motor.

NOTE:

Before tilting up, leave the outboard motor in the running position for one minute after stopping the engine to drain the water from inside the engine.

Stop the engine and disconnect the fuel line from the outboard motor before tilting the outboard motor.

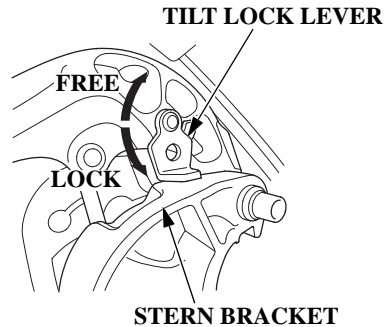

1. Raise the outboard motor as full as it goes using the power trim/tilt switch.
2. Move the tilt lock lever to the LOCK position and lower the outboard motor until the lock lever contacts the stern bracket.
3. Press the DN (down) of the power trim/tilt switch and fully shorten the trim rods.
4. To tilt down, raise the outboard motor slightly, move the tilt lock lever to the FREE position.

NOTE:

After tilting down the outboard motors, adjust the trim angle of the right and left outboard motors.

POWER TRIM/TILT SWITCH (LEFT) (RIGHT)

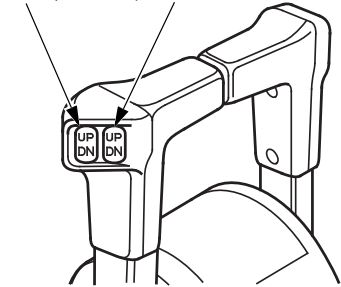

TRIM RODS

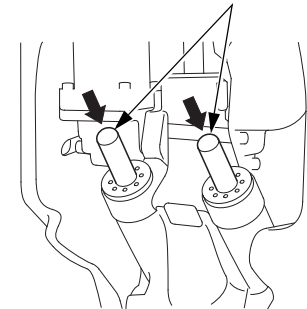

Power Tilt Switch

POWER TILT SWITCH

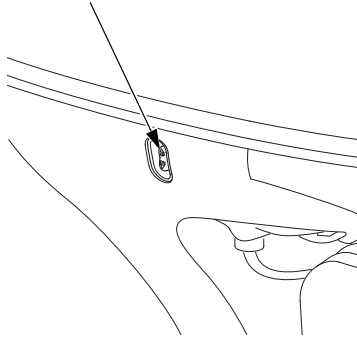

When you are away from the power trim/tilt switch on the control lever side, you can operate the power trim/tilt switch on the outboard motor side. The switch operation is the same as that of the switch on the control lever side.

▲ CAUTION

Do not operate this power tilt switch on the outboard motor while sailing.

Manual Relief Valve

MANUAL RELIEF VALVE

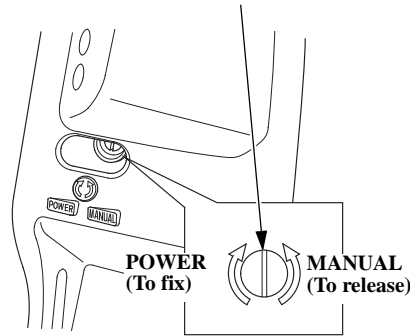

When power trim/tilt system does not operate because of dead battery or faulty power trim/tilt motor, the outboard motor can be manually tilted up or down by operating the manual relief valve.

Check that no person is under the outboard motor before carrying out this operation because if the manual relief valve is loosened (turned counterclockwise) when the outboard motor is tilted up, the outboard motor will suddenly tilt down.

To tilt the outboard motor manually, turn the manual relief valve under the stern bracket 1 or 2 turns counterclockwise using a screwdriver.

After tilting up/down manually, close the manual relief valve to lock the outboard motor in the position.

▲ CAUTION

The manual relief valve must be tightened securely before operating the outboard motor or the outboard motor could tilt when operating in reverse.

OPERATION

Trim Tab Adjustment

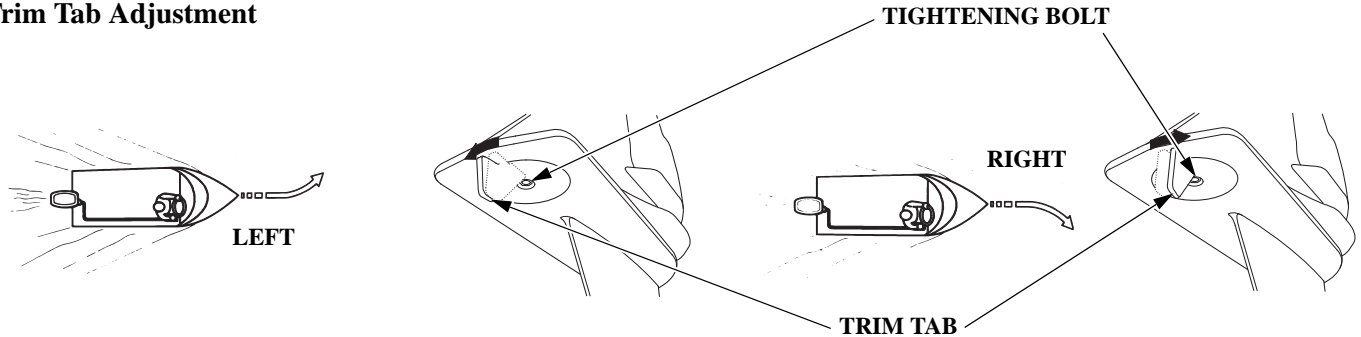

The trim tab is provided to adjust for “torque steer” which is a reaction of the propeller rotation or propeller torque. If during a high speed turn an unequal amount of effort is required to turn the boat right or left, adjust the trim tab so that an equal amount of effort is required.

Distribute the load evenly in the boat and run the boat in a straight course at full throttle. Slightly turn the steering wheel for both right and left turns to determine the amount of effort required.

If less effort is required to make left turns:

Loosen the trim tab tightening bolt and turn the rear end of the trim tab toward the left. Tighten the bolt securely.

If less effort is required to make right turns:

Loosen the trim tab tightening bolt and turn the rear end of the trim tab toward the right. Tighten the bolt securely.

Make small adjustments at a time and retest. Incorrect trim tab adjustment can cause adverse steering.

NOTICE

Painting or coating the anode will lead to rust and corrosion damage to the outboard motor.

Engine Protection System <Engine Oil Pressure, Overheat, Water Separator, PGM-FI and ACG Warning Systems>

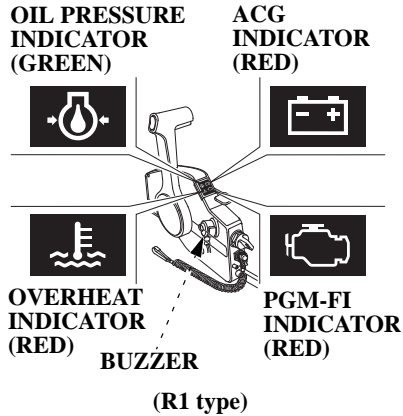

If the engine oil pressure drops and/or the engine overheats, either or both warning systems could be activated. When activated the engine speed will decrease gradually and the green oil pressure indicator will turn OFF and the red overheat indicator will turn ON. A continuous buzzer will sound

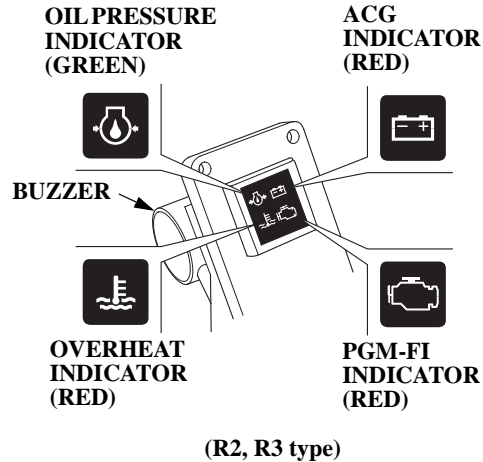

on all type. The engine speed can not be increased with a larger throttle opening until the malfunction is corrected. When the malfunction is corrected the engine speed will increase gradually.

If the engine overheats, the engine will stop in 20 seconds after the engine protection system will limit engine speed. Each warning system of PGM-FI, ACG, oil pressure, overheat, and water separator is activated as described in the following table.

OPERATION

Symptom \ System	INDICATOR				BUZZER
	Oil pressure (Green)	Overheat (Red)	ACG (Red)	PGM-FI (Red)	CORRESPONDING SYSTEM
At starting	ON (2 sec)	ON (2 sec)	ON	ON (2 sec)	With the engine switch key turned on: ON (2 times)
During operation	ON	OFF	OFF	OFF	OFF
Low oil pressure	OFF	OFF	OFF	OFF	ON (continuously)
Overheat	ON	ON	OFF	OFF	ON (continuously)
ACG warning	ON	OFF	ON	OFF	alternating ON and OFF (at long intervals)
PGM-FI warning	ON*	OFF*	OFF	ON	alternating ON and OFF (at long intervals)
Water contamination	ON	OFF	OFF	OFF	alternating ON and OFF (at short intervals)

NOTE:

Some indicator and/or buzzer will be activated at the same time due to the occurrence of a malfunction.

*: Occasionally may blink due to the occurrence of a malfunction.

When the oil pressure warning system is activated:

1. Stop the engine immediately and check the engine oil level (see page 42).
2. If the oil is up to the recommended level, restart the engine. If the oil pressure warning system stops after 30 seconds, the system is normal.

NOTE:

If the throttle was closed suddenly after cruising at full throttle, the engine speed may drop below the specified idle speed. This could cause the oil pressure warning system to activate momentarily.

3. If the oil pressure warning system stays activated after 30 seconds, return to the closest boat landing and contact your closest authorized TOHATSU outboard motor dealer.

COOLING WATER CHECK HOLE

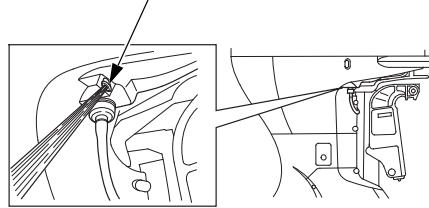

When the overheat warning system is activated:

1. Return the gearshift lever or control lever to the N (neutral) position immediately. Check to see if water is flowing out of the cooling water check hole.
2. If water is flowing out of the cooling water check hole, continue idling for 30 seconds. If the overheat warning system stops after 30 seconds the system is normal.

NOTE:

If the engine is turned off after running at full throttle, the engine temperature may rise above normal. If the engine is restarted, shortly after being turned off, the overheat warning system could be activated momentarily.

OPERATION

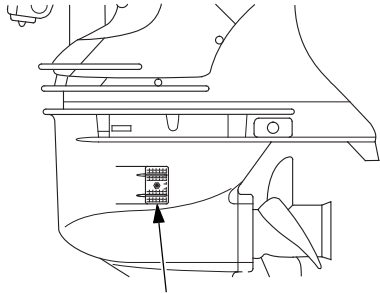

**COOLING WATER INTAKE PORT
(each side)**

3. If the overheat warning system stays activated, stop the engine. Tilt up the outboard motor and check the water intakes for obstructions. If there are no obstructions at the water intakes, return to the closest boat landing and contact your closest authorized TOHATSU outboard motor dealer.

When the PGM-FI activated:

1. Consult with an authorized TOHATSU outboard motor dealer.

When the ACG warning system is activated.

1. Check the battery (see page 98). If the battery is OK, consult with an authorized TOHATSU outboard motor dealer.

WATER SEPARATOR

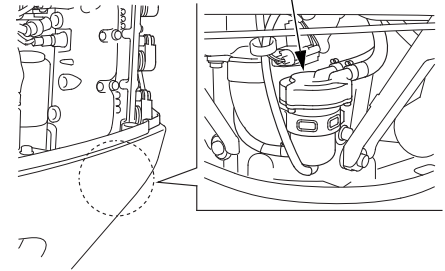

When the water separator buzzer sounds:

1. Check the water separator for water contamination. If water is accumulated, drain them (see page 92).

<Over-rev Limiter>

This outboard motor is equipped with an engine over-rev limiter which activates when the engine speed increases excessively. The over-rev limiter can be activated while cruising, tilting up the outboard motor, or when ventilation occurs during a sharp turn.

When the over-rev limiter is activated:

1. Reduce the throttle opening immediately and check the trim angle.
2. If the trim angle is correct but the over-rev limiter stays activated, stop the engine, check the condition of the outboard motor, check to see if the correct propeller is installed and check it for damage.

Correct or service as necessary, by contacting your authorized TOHATSU outboard motor dealer.

<Anode>

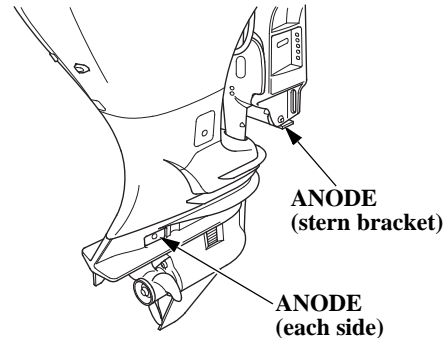

The anode is a sacrificial material which helps to protect the outboard motor from corrosion.

NOTICE

Painting or coating the anode will lead to rust and corrosion damage to the outboard motor.

There are also 4 small sacrificial anodes in the water passages of the engine block.

Shallow Water Operation

NOTICE

Excessive trim/tilt angle during operation can cause the propeller to raise out of the water and cause propeller ventilation and engine over-revving. Excessive trim/tilt angle can also damage the water pump and overheat the engine.

When operating in shallow water, tilt the outboard motor up to prevent the propeller and gear case from hitting the bottom (see page 65). With the outboard motor tilted up, operate the outboard motor at low speed.

Monitor the cooling water check hole for water discharge. Be sure that the outboard motor is not tilted so high that the water intakes are out of the water.

OPERATION

Multiple Outboard Motors

On boats equipped with more than one outboard motor, all motors normally operate at the same time.

If one or more motor(s) is stopped while the other(s) is running, put the stopped motor in “N” (neutral) and tilt it up so its propeller is above the water’s surface.

If the propeller of the stopped motor is left in the water, it may turn as the boat moves through the water, causing a reverse flow of water from the exhaust side. This reverse flow will happen if the stopped engine’s propeller is in the water, its gearshift is in “R” (reverse), and the boat is moving forward. Reverse flow can cause an engine malfunction.

9. STOPPING THE ENGINE

Emergency Engine Stop

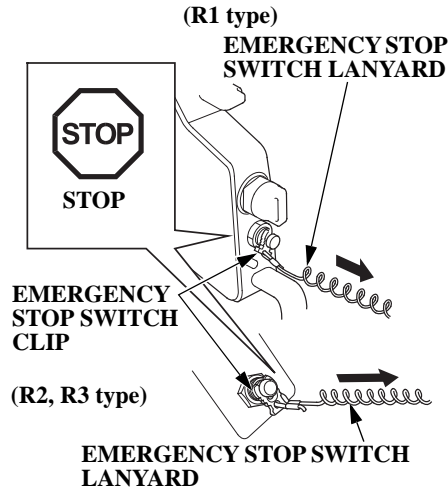

Pull the curl cord of the emergency stop switch and remove the lock plate from the switch; this will stop the engine.

NOTE:

It is a good idea to stop the engine with the emergency stop switch lanyard from time to time to be sure that the emergency stop switch is operating properly.

Normal Engine Stop

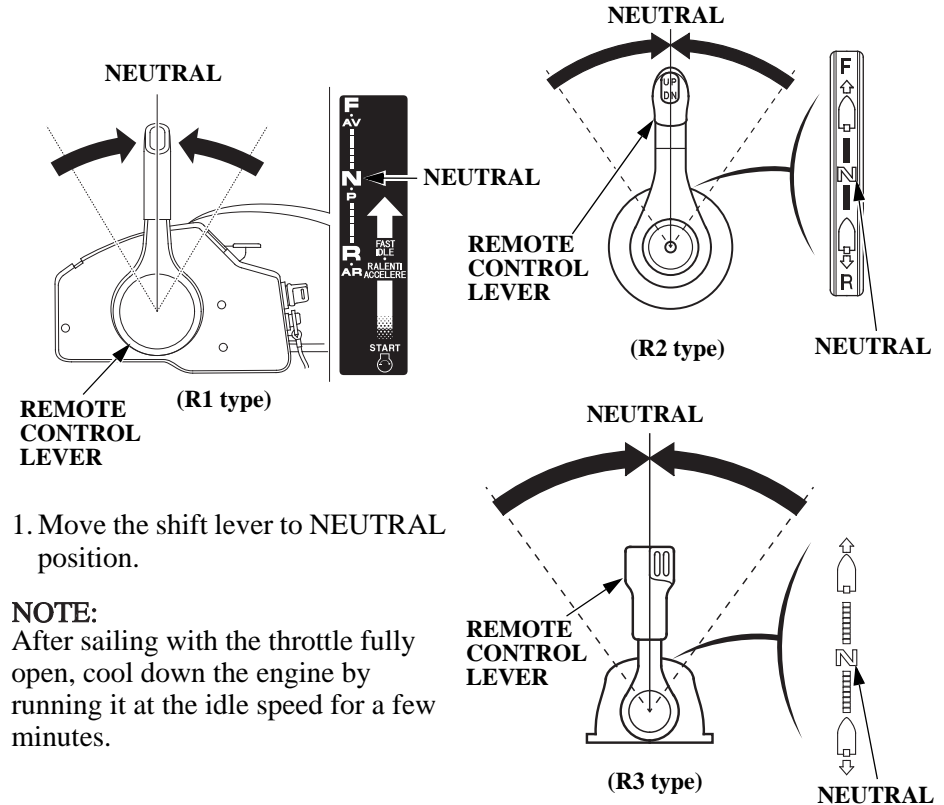

1. Move the shift lever to NEUTRAL position.

NOTE:

After sailing with the throttle fully open, cool down the engine by running it at the idle speed for a few minutes.

STOPPING THE ENGINE

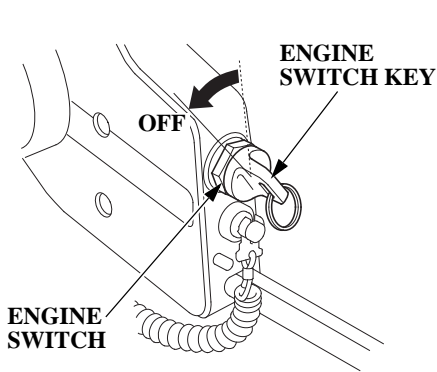

(R1 type)

2. Turn the engine switch key to the OFF position to stop the engine.

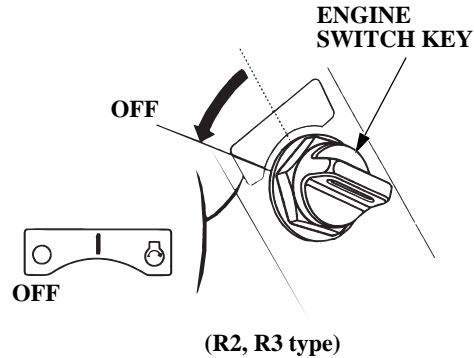

NOTE:

In the event that the engine does not stop when the engine switch is turned to OFF, disconnect the fuel line connector from the outboard motor.

3. Remove the engine switch key and store it.

If you are using a portable fuel tank, disconnect the fuel line if you will be storing or transporting the outboard motor.

Fuel Line Disconnection

Before transporting the outboard motor, disconnect and remove the fuel line.

▲WARNING

Gasoline is extremely flammable, and gasoline vapor can explode, causing serious injury or death.

- **Be careful not to spill fuel. Spilled fuel or fuel vapor may ignite. If any fuel is spilled, make sure the area is dry before storing or transporting the outboard motor.**
- **Do not smoke or allow flames or sparks where fuel is drained or stored.**

Transporting

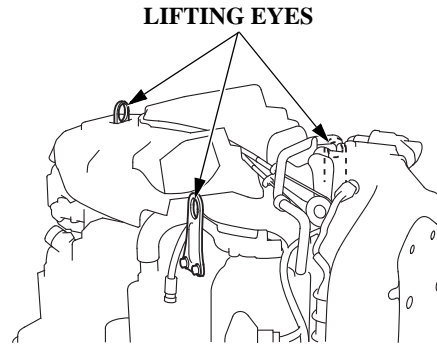

When transporting the outboard motor on a vehicle, perform the following.

1. Remove the engine cover (see page 39).

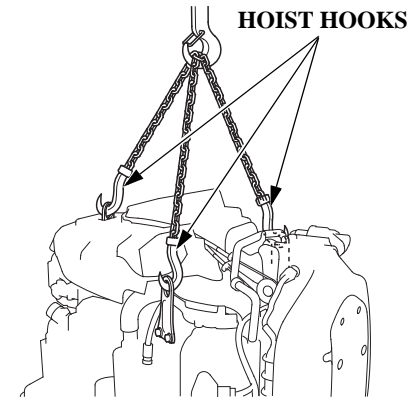

2. Set the hoist hooks against the lifting eyes and hang the outboard motor to remove it from the boat.

TRANSPORTING

OUTBOARD MOTOR STAND

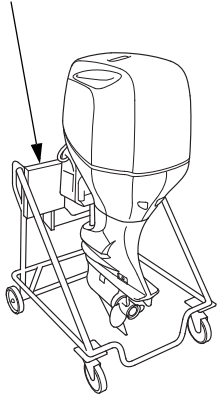

3. Secure the outboard motor on an outboard motor stand with the mounting bolts and nuts.
4. Remove the hoist hook and reinstall the engine cover (see page 39).

Trailer

When trailering or transporting the boat with the outboard motor attached, it is recommended that the outboard motor remain in normal running position.

NOTICE

Do not trailer or transport the boat with the outboard motor in the tilted position. The boat or outboard motor could be severely damaged if the outboard motor drops.

The outboard motor should be trailered in the normal running position. If there is insufficient road clearance in this position, then trailer the outboard motor in the tilted position using an outboard motor support device such as a transom saver bar, or remove the outboard motor from the boat.

11. CLEANING AND FLUSHING

After each use in salt water or dirty water, thoroughly clean and flush the outboard motor with fresh water.

NOTICE

Do not apply water or corrosion inhibitor directly to the electrical components under the engine cover, such as the AC generator, O2 sensor, or the AC generator belt, timing belt. If water or corrosion inhibitor penetrates these components, they may be damaged. Before applying a corrosion inhibitor, cover the AC generator, belts and O2 sensor with a protective material to prevent damage.

Shut off the engine before performing the cleaning and flushing.

1. Disconnect the fuel line from the outboard motor.
2. Tilt down the outboard motor.
3. Wash the outside of the outboard motor with clean, fresh water.

FLUSH PLUG CONNECTOR

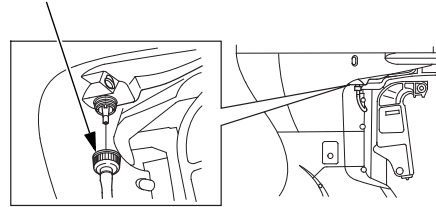

4. Remove the flush plug connector from the outboard motor.
5. Install the water hose joint (commercially available).

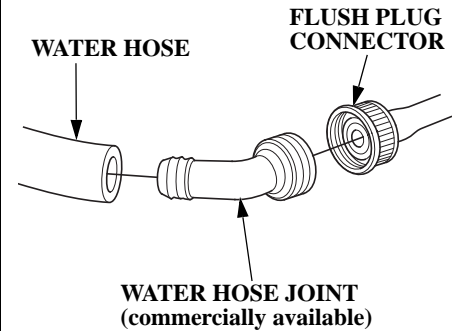

6. Connect a fresh water hose to the water hose joint.
7. Turn on the fresh water supply to the hose and flush the engine for at least 10 minutes.
8. After flushing, remove the water hose and water hose joint and reinstall the flush plug connector.
9. Tilt up the outboard motor and move the tilt lock lever to the LOCK position.

12. MAINTENANCE

Periodic maintenance and adjustment are important to keep the outboard motor in the best operating condition. Service and inspect according to the MAINTENANCE SCHEDULE.

▲WARNING

Shut off the engine before performing any maintenance. If the engine must be run, make sure the area is well ventilated. Never run the engine in an enclosed or confined area. Exhaust contains poisonous carbon monoxide gas; exposure can cause loss of consciousness and may lead to death.

Be sure to reinstall the engine cover, if it was removed, before starting the engine. Lock it securely by pulling up the lock lever.

NOTICE

- **If the engine must be run, make sure there is water at least 100 mm (4 in) above the anticavitation plate, otherwise the water pump may not receive sufficient cooling water, and the engine will overheat.**
- **Use only TOHATSU Genuine parts or their equivalents for maintenance or repair. The use of replacement parts which are not of equivalent quality may damage the outboard motor.**

**Tool Kit and Spare Parts
(Tool Kit does not come with
Counter Rotation Types)**

The following tools and owner's manual are supplied with the outboard motor for maintenance, adjustment, and emergency repairs.

**<Spare Emergency Stop Switch
Clip>**

A spare emergency stop switch clip does not come with R2, R3 type (see page 26).

A spare emergency stop switch clip is available from your outboard motor dealer.

Always carry a spare emergency stop switch clip onboard. The spare clip may either be stored in the tool bag or in an easily accessible location on the boat.

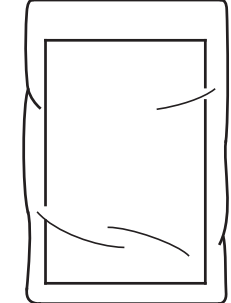

OWNER'S MANUAL



TOOL BAG



10 mm BOX WRENCH



FLAT SCREWDRIVER



GRIP

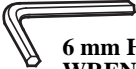

**6 mm HEX.
WRENCH**

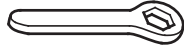

19 mm EYE WRENCH



**SPARK PLUG
WRENCH**

MAINTENANCE

MAINTENANCE SCHEDULE

ITEM	REGULAR SERVICE PERIOD (3) Perform at every indicated month or operating hour interval, whichever comes first.		Each use	After use	First month or 20 hrs.	Every 6 months or 100 hrs.	Every year or 200 hrs.	Every 2 years or 400 hrs.	Every 6 years or 1,200 hrs.	Refer to page
Engine oil	Check level		o							41
	Change				o	o				84
Engine oil filter	Replace						o (2)			—
Gear case oil	Change				o (2)	o (2)				—
Timing belt	Check-adjust						o (2)			—
ACG belt	Check-adjust						o (2)			—
Throttle linkage	Check-adjust				o (2)	o (2)				—
Valve clearance	Check-adjust						o (2)			—
Spark plug	Check-Clean/Replace					o				86
	(Optional part) Check						o			89
	(Optional part) Clean						o (2)			—
	(Optional part) Replace							o		89
Propeller and cotter pin	Check		o							44
Anode metal (Outside engine)	Check		o							47
Anode metal (Inside engine) (6)	Sleeve	Check						o (2)		—
	Exhaust manifold	Check						o (2)		—
	V bank bottom	Replace							o (2)	—
Idling speed	Check-adjust				o (2)	o (2)				—
Lubrication	Grease				o (1)	o (1)				90
Water separator	Check					o				94
Fuel filter	Check		o			o				91
	Replace							o		93

NOTE:

- (1) Lubricate more frequently when used in salt water.
- (2) These items should be serviced by your servicing dealer, unless you have the proper tools and are mechanically proficient. Refer to the TOHATSU Service Manual for service procedures.
- (3) For professional commercial use, log hours of operation to determine proper maintenance intervals.
- (6) Replace the anodes when they have been reduced to about two-thirds of their original size, or if they are crumbling.

MAINTENANCE

ITEM	REGULAR SERVICE PERIOD (3) Perform at every indicated month or operating hour interval, whichever comes first.	Each use	After use	First month or 20 hrs.	Every 6 months or 100 hrs.	Every year or 200 hrs.	Every 2 years or 400 hrs.	Every 6 years or 1,200 hrs.	Refer to page
Fuel filter (High pressure type)	Check				o (2)				—
	Replace						o (2)		—
Thermostat and thermostat cover	Check					o (2)			—
Fuel line	Check	o (8)							47
	Replace				Every 2 years (if necessary) (2) (9)				—
Battery and cable connection	Check level-tightness	o							46, 98
Bolts and nuts	Check-tightness			o (2)	o (2)				—
Crankcase breather tube	Check					o (2)			—
Cooling water passages	Clean		o (4)		o (4)				—
Coolant leak	Check		o						103
Water pump	Check					o (2)			—
Housing, Impeller	Check					o (2)			—
Emergency stop switch	Check	o							25
Engine oil leak	Check	o							—
Each operation part	Check	o							—
Engine condition (5)	Check	o							—
Power Trim/Tilt	Check				o (2)				—
Shift cable	Check-adjust				o (2) (7)				—

NOTE:

- (2) These items should be serviced by your servicing dealer, unless you have the proper tools and are mechanically proficient. Refer to the TOHATSU Service Manual for service procedures.
- (3) For professional commercial use, log hours of operation to determine proper maintenance intervals.
- (4) When operating in salt water, turbid or muddy water, the engine should be flushed with clean water after each use.
- (5) Upon starting, check for unusual engine sounds and cooling water flowing freely from the check hole.
- (7) The user who performs shift operation frequently will recommend you exchange of a shift cable around three years.
- (8) Check the fuel line for leaks, cracks, or damage. If it is leaking, cracked, or damaged, take it to your servicing dealer for replacement before using your outboard.
- (9) Replace the fuel line if there are signs of leaks, cracks, or damage.

MAINTENANCE

Engine Oil

Insufficient or contaminated engine oil adversely affects the service life of the sliding and moving parts.

Oil change interval:

20 operating hours after the date of purchase or first month for initial replacement, then every 100 operating hours or 6 months.

Oil capacity:

7.6 L (8.0 US qt, 6.7 Imp qt)

...when oil filter is not replaced

7.8 L (8.2 US qt, 6.9 Imp qt)

...when oil filter is replaced

Recommended Oil:

SAE 10W-30 engine oil or equivalent, API Service category SG, SH or SJ.

Engine Oil Replacement

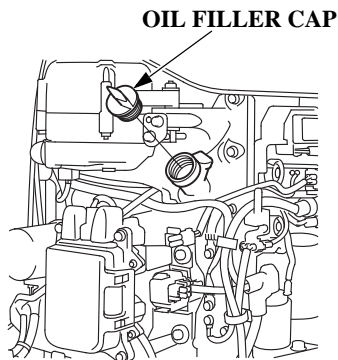

Drain the oil while the engine is still warm to assure rapid and complete draining.

1. Position the outboard motor vertically, and remove the engine cover (see page 39). Remove the oil filler cap.

DRAIN PLUG COVER

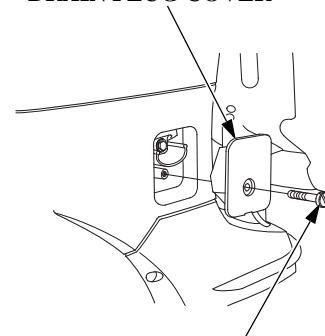

DRAIN PLUG COVER SCREW

2. Loosen the drain plug cover screw using a flat screwdriver and remove the drain plug cover.

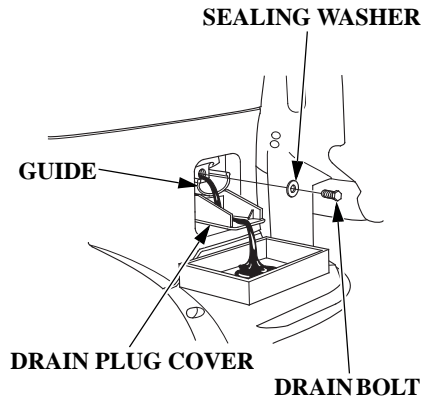

3. Set the drain plug cover under the guide.
4. Place a suitable container under the guide.
5. Remove the engine oil drain bolt and sealing washer using the 12 mm wrench and drain the engine oil.

Install a new sealing washer and drain bolt, and tighten bolt securely.

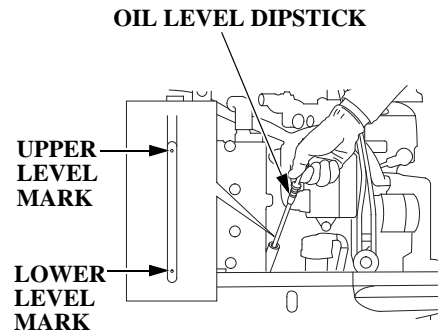

6. Refill to the upper level mark on the oil level dipstick with the recommended oil.

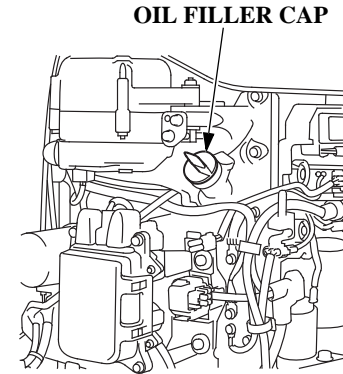

7. Reinstall the oil filler cap securely. Do not overtighten.

NOTE:

Please dispose of used outboard motor oil in a manner that is compatible with the environment. We suggest you take it in a sealed container to your local service station for reclamation. Do not throw it in the trash or pour it on the ground.

Wash your hands with soap and water after handling used oil.

MAINTENANCE

Spark Plugs

<Standard Spark Plug>

To ensure proper engine operation, the spark plug must be properly gapped and free of deposits.

▲ CAUTION

The spark plug becomes very hot during operation and will remain hot for a while after stopping the engine. Allow the engine to cool before servicing the spark plug.

Check-clean/Replace interval:

Every 100 operating hours or 6 months.

Recommended spark plug:

ZFR6K-11E (NGK)

NOTICE

Use only the recommended spark plugs or equivalent. Spark plugs which have an improper heat range may cause engine damage.

See page 89 for instructions of handling the Iridium spark plugs (optional parts).

1. Disconnect the battery negative (-) terminal.
2. Unlock and remove the engine cover (see page 39).

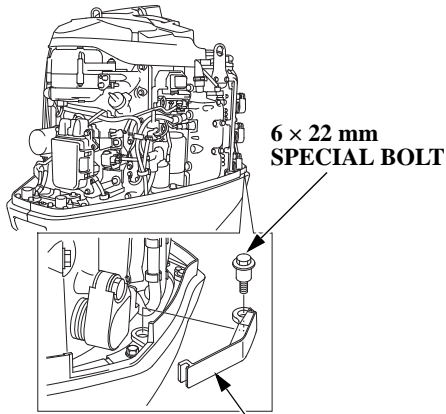

3. Remove the 6 × 22 mm special bolt and remove the plug maintenance cover.

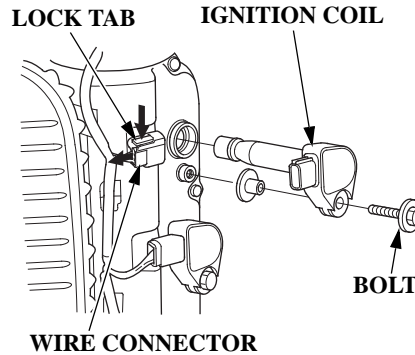

4. Disconnect the wire connector from the ignition coil by pushing on the lock tab and pulling on the connector. Pull on the plastic connector, not the wires.
5. Use a 10 mm wrench to remove the bolt holding the ignition coil. Remove the ignition coil by pulling it up slightly. Take care not give an impact or drop the ignition coil. Replace the ignition coil if drop it.

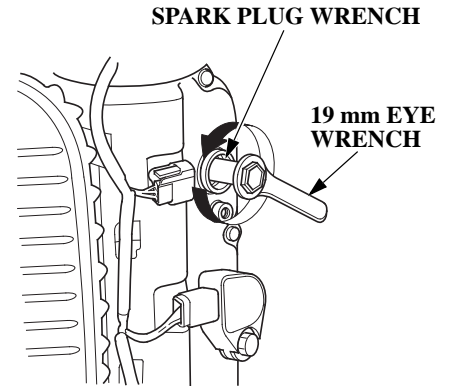

6. Use the spark plug wrench and 19 mm eye wrench to remove the spark plugs.

MAINTENANCE

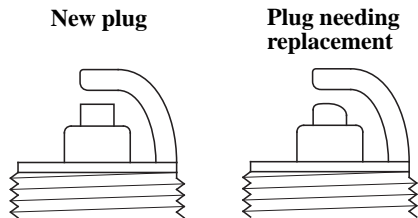

7. Inspect the spark plugs.

- (1) If the electrodes are heavily corroded or carbon-soiled, clean with a wire brush.
- (2) Replace a spark plug if the central electrode is worn. The spark plug can wear out in different ways. If the sealing washer shows signs of wear, or if the insulators are cracked or chipped, replace the spark plugs.

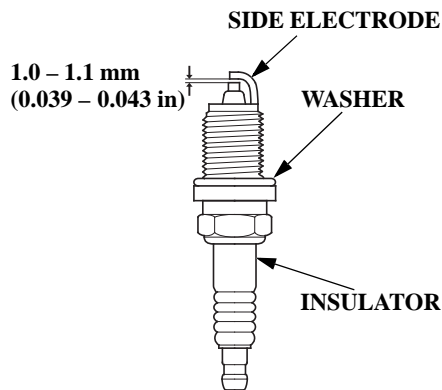

8. Measure the plug gaps with a feeler gauge. Correct the gap, if necessary, by carefully bending the side electrode.

The gap should be:
1.0 - 1.1 mm (0.039 - 0.043 in)

9. Thread the plugs in by hand to prevent cross threading.
10. After the spark plugs are seated, tighten with a spark plug wrench to compress the washers.

NOTE:

If installing new spark plugs, tighten 1/2 turn after the spark plugs seat to compress the washers.

If reinstalling used spark plugs, tighten 1/8 - 1/4 turn after the spark plugs seat to compress the washers.

NOTICE

The spark plugs must be securely tightened. An improperly tightened plug can become very hot and may cause engine damage.

11. Install the ignition coil. Reinstall the bolt.
12. Push the wire connector onto the ignition coil. Make sure it locks in place.
13. Repeat this procedure for the other five spark plugs.
14. Reinstall the covers. When reinstalling the covers, make sure not to jam the wire harnesses in between the covers and engine case.

Spark Plugs

<Optional Parts: Iridium Spark Plug>

To ensure proper engine operation, the spark plug must be properly gapped and free of deposits.

▲ CAUTION

The spark plug becomes very hot during operation and will remain hot for a while after stopping the engine. Allow the engine to cool before servicing the spark plug.

Check/Clean interval:

Every 200 operating hours or every year.

Replace interval:

Every 400 hours or 2 years

Recommended spark plug:

IZFR6K-11E (NGK)

NOTICE

Use only the recommended spark plugs or equivalent. Spark plugs which have an improper heat range may cause engine damage.

Installation and removal procedure of the Iridium spark plugs are the same as the standard spark plugs.

These spark plugs have an iridium coated center electrode. Be sure to observe the following when servicing iridium spark plugs.

- Do not clean the spark plugs. If an electrode is contaminated with accumulated objects or dirt, replace the spark plug with a new one. The cleaning of the iridium spark plugs consult with your servicing dealer, unless the owner has the proper tools and is mechanically proficient.

- Use only a “wire-type feeler gauge” to check the spark plug gap if necessary. To prevent damaging the iridium coating of the center electrode, never use a “leaf-type feeler gauge.”
The gaps should be 1.0 – 1.3 mm (0.039 – 0.051 in).
- Do not adjust the spark plug gap. If the gap is out of specification, replace the spark plug with a new one.

MAINTENANCE

Lubrication

Wipe the outside of the engine with a cloth dipped in clean oil. Apply marine anticorrosion grease to the following parts:

Lubrication interval:

20 hours or a month after the date of purchase for initial lubrication, then every 100 hours or 6 months.

NOTE:

- Apply anticorrosion oil to pivot surfaces where grease cannot penetrate.
- Lubricate more frequently when used in salt water.

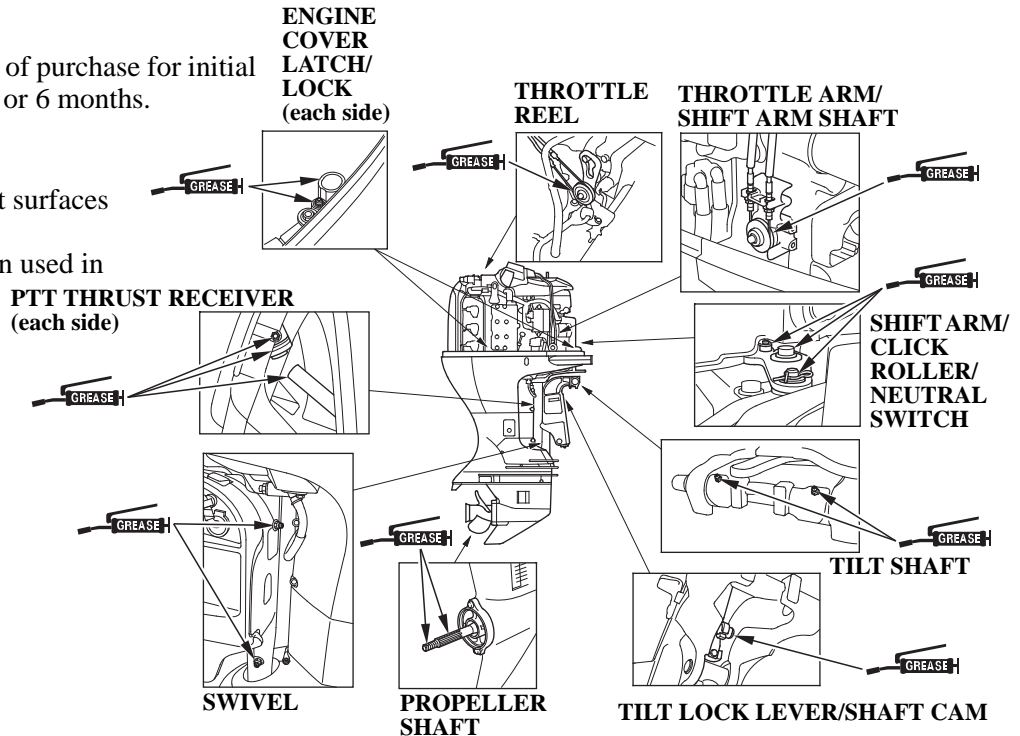

Fuel Filter

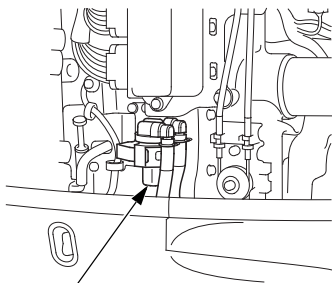

FUEL FILTER
(inside strainer cup)

The fuel filter (inside the strainer cup) is located beside the oil level dipstick.

Water or sediment accumulated in the fuel filter can cause loss of power or hard starting. Check and replace the fuel filter periodically.

Inspection interval:

Every 100 operating hours or 6 months.

Replacement interval:

Every 400 operating hours or 2 years

▲WARNING

Gasoline is extremely flammable, and gasoline vapor can explode, causing serious injury or death. Do not smoke or allow flames or sparks in your working area. KEEP OUT OF REACH OF CHILDREN.

- Always work in a well-ventilated area.
- Be sure that any fuel drained from the outboard motor is stored in a safe container.
- Be careful not to spill fuel when replacing the filter. Spilled fuel or fuel vapor may ignite. If any fuel is spilled, make sure the area is dry before starting the engine.

MAINTENANCE

<Inspection>

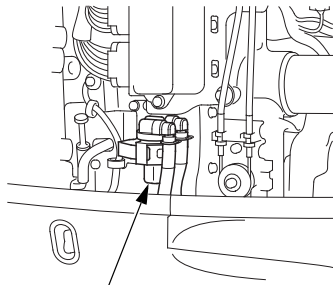

FUEL FILTER
(inside strainer cup)

1. Remove the engine cover (see page 39).
2. Looking through the translucent strainer cup, check the fuel filter for water accumulation and clogging.
If the fuel filter is clogged, refer to page 93 to remove the filter and clean it.

If a water is remained in the fuel filter, refer to page 93 to remove the strainer cup and empty the water from the inside of the cup. Then drain the water by following procedure.

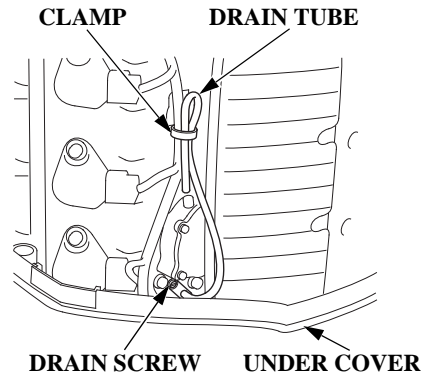

1. Remove the drain tube held by the clamp on the left cylinder head cover, and move the tip of the drain tube which is inside of the under cover to the outside.

2. Loosen the drain screw with the flat tip screwdriver.
3. Send the fuel by using the primer bulb (see page 48).
4. Once the water has drained out of the drain tube and gasoline starts to flow out of the drain tube, stop pushing the primer bulb. (Five times may be required to drain the water.)
Store the gasoline in a suitable container.
5. When the gasoline flowing is stopped, tighten the drain screw, and hold the drain tube by the clamp on the cylinder head cover.
6. Check for fuel leaks while squeezing the priming bulb.

<Replacement>

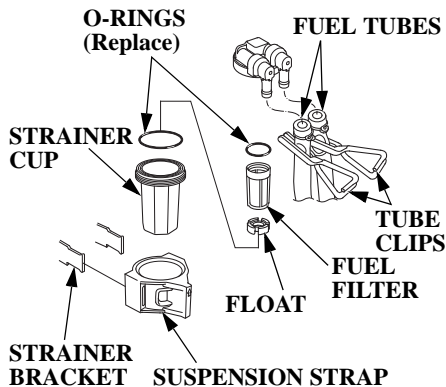

1. Remove the suspension strap from the strainer bracket, then remove the strap from the strainer assembly.

NOTE:

Before removing the filter, pinch the fuel tubes on each side of filter using tube clips to prevent fuel leakage.

2. Disconnect the fuel tubes from the strainer assembly.

3. Unscrew the strainer cup.
4. Thoroughly clean the strainer cup, and replace with a new fuel filter.
5. Reassemble the fuel filter, float and strainer cup using new O-rings.
6. Install the suspension strap to the strainer assembly.
7. Align the center of the two fuel tubes and arrow of the suspension strap rib.

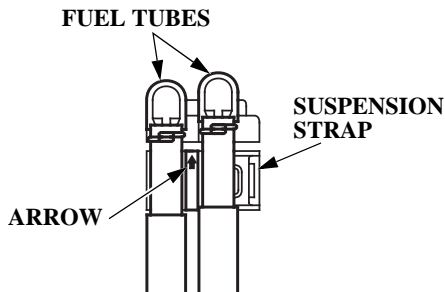

8. Connect the fuel tubes to the strainer assembly securely with the tube clamps. Remove the tube clips used to close the fuel tubes.
9. Reinstall the strainer assembly in the reverse order of removal.
10. Prime the engine using the priming bulb (see page 48). Check for fuel leaks. Repair any fuel leaks if necessary.

NOTE:

If loss of power or hard starting is found caused by excessive water or sediment accumulated in the fuel filter, inspect the fuel tank. Clean the fuel tank if necessary.

MAINTENANCE

Water Separator

No.6 CYLINDER IGNITION COIL WATER SEPARATOR

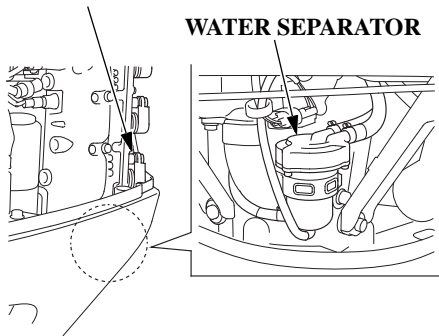

Water separator is located under No.6 cylinder ignition coil. Water accumulation in the water separator can cause loss of power or hard starting. Check the water separator periodically. Clean it or consult with an authorized TOHATSU outboard motor dealer for cleaning.

▲WARNING

Gasoline is extremely flammable, and gasoline vapor can explode, causing serious injury or death. Do not smoke or allow flames or sparks in your working area.

KEEP OUT OF REACH OF CHILDREN.

- Always work in a well-ventilated area.
- Be sure that any fuel drained from the outboard motor is stored in a safe container.
- Be careful not to spill fuel when replacing the filter. Spilled fuel or fuel vapor may ignite. If any fuel is spilled, make sure the area is dry before starting the engine.

<Cleaning>

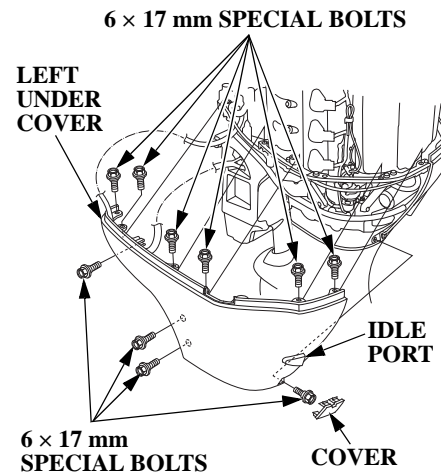

1. Remove the engine cover (see page 39).
2. Remove the spark plug maintenance cover (see page 87).
3. Remove the cover under the idle port.
4. Remove the left under cover by removing the 6 x 17 mm special bolts.

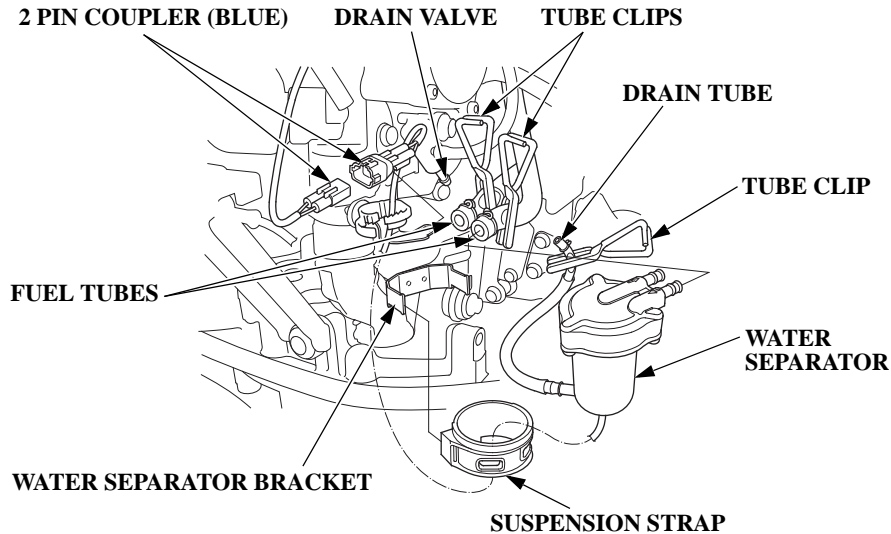

5. Disconnect the 2-pin coupler (blue).
6. Remove the suspension strap from the water separator bracket, then remove the suspension strap from the water separator.
7. Bind the two fuel tubes with the tube clips to prevent the fuel leakage, disconnect the fuel tubes.

8. Bind the drain tube with the tube clip, disconnect the tube from the drain valve.

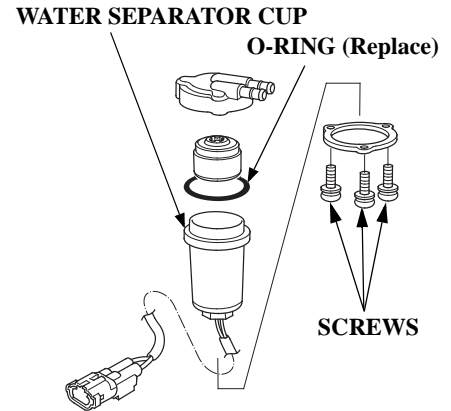

9. Remove the three screws holding the water separator, delete the water or deposit from the inside of the cup.
 10. Reassemble the water separator in the reverse order of removal. Use a new O-ring.
- TIGHTENING TORQUE:**
3.4 N·m (0.34 kgf·m, 2.5 lbf·ft)

MAINTENANCE

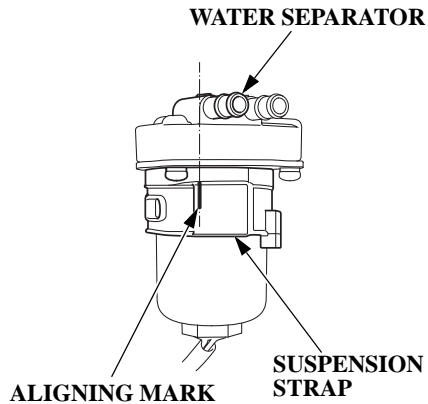

11. Align the aligning mark as shown in the figure, when installing the suspension strap on the water separator.

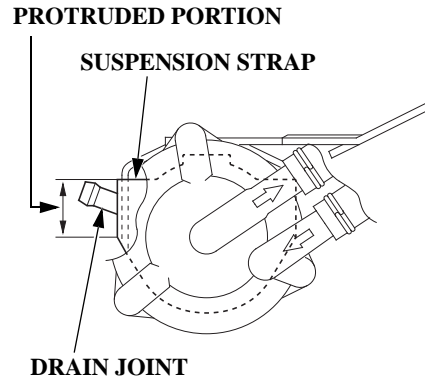

12. The drain joint should be positioned within the protruded portion of the suspension strap as shown in the figure.
13. Prime the engine using the priming bulb (see page 48). Check for fuel leaks. Repair any fuel leaks if necessary.

NOTE:

If the buzzer sounds, water or sediment accumulation is found to be caused by excessive water or sediment accumulated in the fuel filter, inspect the fuel tank. Clean the fuel tank if necessary.

EMISSION CONTROL SYSTEM

The combustion process produces carbon monoxide and hydrocarbons. Control of hydrocarbons is very important because under certain conditions, they react to form photochemical smog when subjected to sunlight. Carbon monoxide does not react in the same way, but it is toxic.

Problems that May Affect Outboard Motor Emissions

If you are aware of any of the following symptoms, have the outboard motor inspected and repaired by your authorized TOHATSU Dealer:

1. Hard starting or stalling after starting
2. Rough idle
3. Misfiring or backfiring during acceleration
4. Poor performance (driveability) and poor fuel economy

MAINTENANCE

Battery

NOTICE

Battery handling differs according to the type of the battery and the instructions described below might not be applicable to the battery of your outboard. Refer to the battery manufacturer's instructions.

▲WARNING

Batteries produce explosive gases: If ignited, an explosion can cause serious injury or blindness. Provide adequate ventilation when charging.

- **CHEMICAL HAZARD:** Battery electrolyte contains sulfuric acid. Contact with eyes or skin, even through clothing, may cause severe burns. Wear a faceshield and protective clothing.

- **Keep flames and sparks away, and do not smoke in the area.**
ANTIDOTE: If electrolyte gets into your eyes, flush thoroughly with warm water for at least 15 minutes and call a physician immediately.
- **POISON:** Electrolyte is poison.
ANTIDOTE:
 - **External:** Flush thoroughly with water.
 - **Internal:** Drink large quantities of water or milk. Follow with milk of magnesia or vegetable oil, and call a physician immediately.
- **KEEP OUT OF REACH OF CHILDREN.**

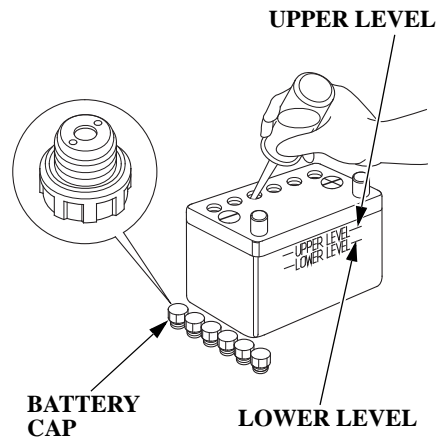

<Battery Fluid Level>

Check whether the battery fluid is between the upper and lower levels, and check the vent hole in the battery caps for clogging.

If the battery fluid is near or below the lower level, add the distilled water to the upper level.

<Battery Cleaning>

1. Disconnect the battery cable at the battery negative (+) terminal, then at the battery positive (-) terminal.
2. Remove the battery and clean the battery terminals and battery cable terminals with a wire brush or sand paper.

Clean the battery with a solution of baking soda and warm water, taking care not to get the solution or water in the battery cells. Dry the battery thoroughly.

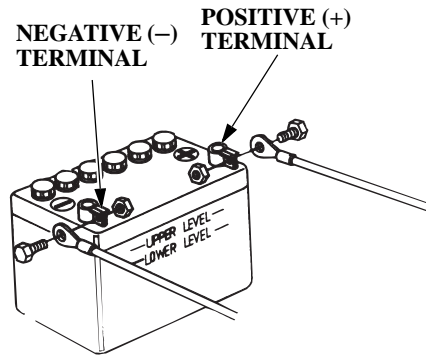

3. Connect the battery positive (+) cable to the battery positive (+) terminal, then the battery negative (-) cable to the battery negative (-) terminal. Tighten the bolts and nuts securely. Coat the battery terminals with grease.

▲ CAUTION

When disconnecting the battery cable, be sure to disconnect at the battery negative (-) terminal first. To connect, connect at the positive (+) terminal first, then at the negative (-) terminal. Never dis/connect the battery cable in the reverse order, or it causes a short circuit when a tool contacts the terminals.

MAINTENANCE

Fuse

Before replacing the fuse, check the current ratings of the electrical accessories and ensure that there are no abnormalities.

▲WARNING

- **Never use a fuse with a different rating from that specified. Serious damage to the electrical system or a fire may result.**
- **Disconnect the battery cable at the battery negative (-) terminal before replacing the fuse. Failure to do so may cause a short circuit.**

NOTICE

If the fuse is blown, check the cause, then replace the fuse with a spare fuse of the same rated capacity. Unless the cause is found, the fuse may blow again.

<Replacement>

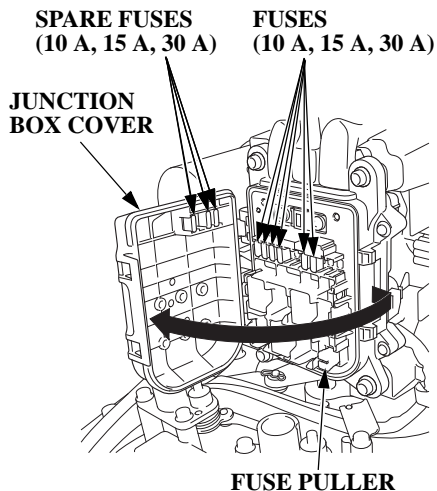

1. Stop the engine.
2. Disconnect the battery (see page 99).
3. Remove the engine cover (see page 39).
4. Open the junction box cover.

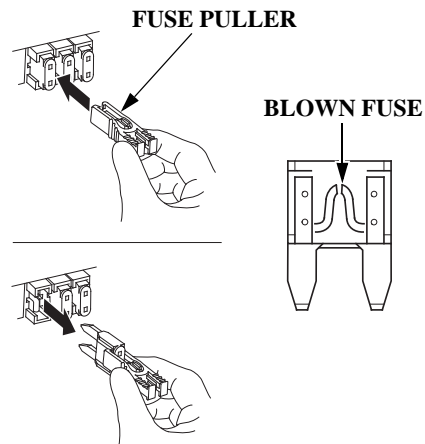

5. Pull the old fuse out of the clip with the fuse puller supplied in the fuse box.
6. Push a new fuse into the clips.

ACG Fuse

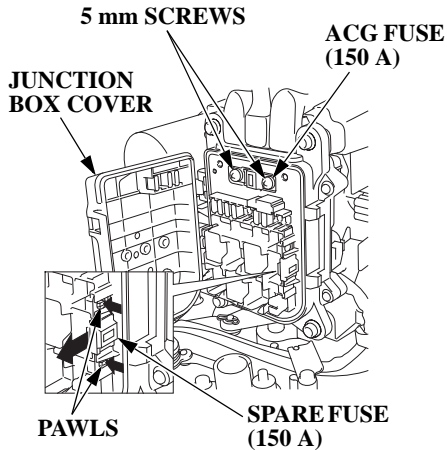

<Replacement>

A spare fuse is located on the junction box.

Push two pawls, then pull out the spare fuse.

1. Stop the engine.
2. Disconnect the battery (see page 99).
3. Remove the engine cover (see page 39).
4. Open the junction box cover.
5. Remove the old fuse by removing two 5 mm screws.
6. Install a new fuse by tightening two 5 mm screws.
7. After finishing replacement, close the junction box cover.

MAINTENANCE

Propeller

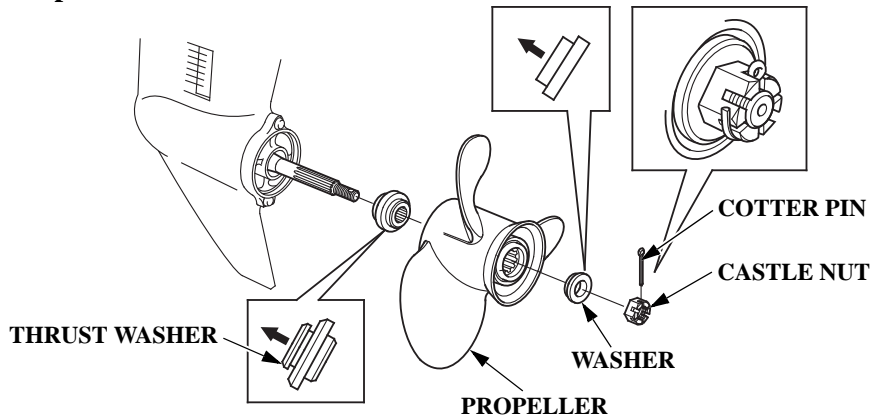

If the propeller is damaged by striking a rock, or other obstacle, replace the propeller as follows.

▲ WARNING

- **When replacing, remove the emergency stop switch clip to prevent an accidental startup of the engine.**
- **The propeller is thin and sharp. To protect your hands, wear the heavy gloves during replacement.**

Replacement

1. Remove the cotter pin then remove the 18 mm castle nut, washer, propeller and thrust washer.
2. Install the new propeller in the reverse sequence to removal.

3. Tighten the castle nut with your hand first until the propeller has no play. Then, tighten the castle nut again with a tool until the groove in the castle nut aligns with the cotter pin hole. (Note that this tool is not included in the tools that come together with the outboard motor.)

CASTLE NUT TIGHTENING TORQUE:

1 N·m (0.1 kgf·m, 0.7 lbf·ft)

UPPER LIMIT OF TORQUE:
44.1 N·m (4.5 kgf·m, 33 lbf·ft)

4. Be sure to replace the cotter pin with a new one.

NOTE:

- Install the thrust washer with the grooved side toward the gear case.
- Use a genuine TOHATSU cotter pin and bend the pin ends as shown.

Inspect After Operating

1. Stop the engine and remove the engine cover (see page 39).
2. Confirm the cooling water leakage from the engine.

Submerged Outboard Motor

A submerged outboard motor must be serviced immediately after it is recovered from the water in order to minimize corrosion.

If there is a TOHATSU outboard motor dealership nearby, take the outboard motor immediately to the dealer. If you are far from a dealership, proceed as follows:

1. Remove the engine cover (see page 39), and rinse the outboard motor with fresh water to remove salt water, sand, mud, etc.

NOTICE

If the outboard motor was running when it submerged, there may be mechanical damage, such as bent connecting rods. If the engine binds when cranked, do not attempt to run the outboard motor until it has been repaired.

2. Change the engine oil (see page 84).
3. Remove the spark plugs (see page 86). Operate the starter to expel water from the engine's cylinder.

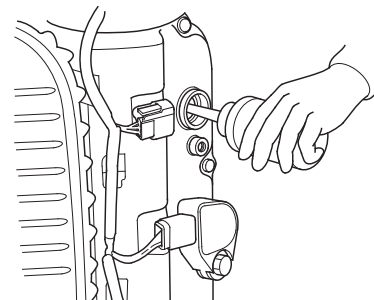

4. Put a teaspoon of engine oil into each spark plug hole to lubricate the inside of the cylinders. Reinstall the spark plugs.
5. Install the engine cover and lock the latch securely (see page 39).

MAINTENANCE

6. Attempt to start the engine.

- If the engine fails to start, remove the spark plugs, clean and dry the electrodes, then reinstall the spark plugs and attempt to start the engine again.
- If there was water in the engine crankcase, or the used engine oil showed signs of water contamination, then a second engine oil change should be performed after running the engine for 1/2 hour.
- If the engine starts, and no mechanical damage is evident, continue to run the engine for 1/2 hour or longer (be sure the water level is at least 100 mm (4 in) above the anticavitation plate).

7. As soon as possible, take the outboard motor to a TOHATSU outboard motor dealer for inspection and service.

For longer service life of the outboard motor, have your outboard motor serviced by an authorized TOHATSU outboard motor dealer before storage. However, the following procedures can be performed by you, the owner, with a minimum of tools.

Fuel

NOTE:

Gasoline spoils very quickly depending on factors such as light exposure, temperature and time.

In worst cases, gasoline can be contaminated within 30 days.

Using contaminated gasoline can seriously damage the engine (fuel system clogged, valve stuck).

Such damage due to spoiled fuel is disallowed from coverage by the warranty.

To avoid this please strictly follow these recommendations:

- Only use specified gasoline (see page 42).
- Use fresh and clean gasoline.

- To slow deterioration, keep gasoline in a certified fuel container.
- If long storage (more than 30 days) is foreseen, drain fuel tank and vapor separator.

STORAGE

Vapor Separator Draining

▲WARNING

Gasoline is extremely flammable, and gasoline vapor can explode, causing serious injury or death. Do not smoke or allow flames or sparks in your working area. KEEP OUT OF REACH OF CHILDREN.

- Be careful not to spill fuel. Spilled fuel or fuel vapor may ignite. If any fuel is spilled, make sure the area is dry before storing or transporting the outboard motor.
- Do not smoke or allow flames or sparks where fuel is drained or stored.

VAPOR SEPARATOR

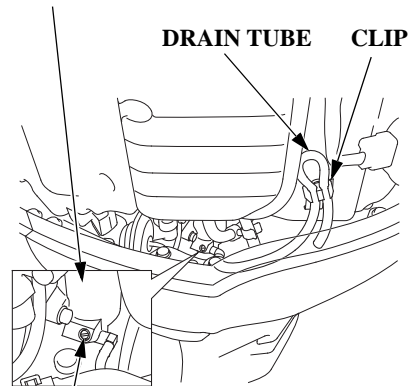

DRAIN BOLT

1. Unhook the drain tube from the clip on the lower left of the head cover.
2. Set the end of the tube toward the outside of the engine undercase.
3. Loosen the vapor separator drain bolt by using a commercially available flat tip screwdriver.
4. Tilt up the outboard motor.
5. Tilt down the outboard motor, and drain the vapor separator.
6. After draining thoroughly, tighten the drain bolt securely.
7. Clip the drain tube on the head cover.

Battery Storage

NOTICE

Battery handling differs according to the type of the battery and the instructions described below might not be applicable to the battery of your outboard motor. Refer to the battery manufacturer's instructions.

▲WARNING

Batteries produce explosive gases: If ignited, an explosion can cause serious injury or blindness. Provide adequate ventilation when charging.

- **CHEMICAL HAZARD:** Battery electrolyte contains sulfuric acid. Contact with eyes or skin, even through clothing, may cause severe burns. Wear a faceshield and protective clothing.

- **Keep flames and sparks away, and do not smoke in the area.**
ANTIDOTE: If electrolyte gets into your eyes, flush thoroughly with warm water for at least 15 minutes and call a physician immediately.
- **POISON:** Electrolyte is poison.
ANTIDOTE
 - **External:** Flush thoroughly with water.
 - **Internal:** Drink large quantities of water or milk. Follow with milk of magnesia or vegetable oil, and call a physician immediately.
- **KEEP OUT OF REACH OF CHILDREN.**

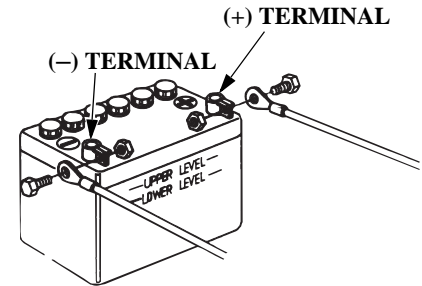

1. Disconnect the battery cable at the battery negative (–) terminal, then at the battery positive (+) terminal.
2. Remove the battery and clean the battery terminals and battery cable terminals with a wire brush or sand paper.
Clean the battery with a solution of baking soda and warm water, taking care not to get the solution of water in the battery cells. Dry the battery thoroughly.

STORAGE

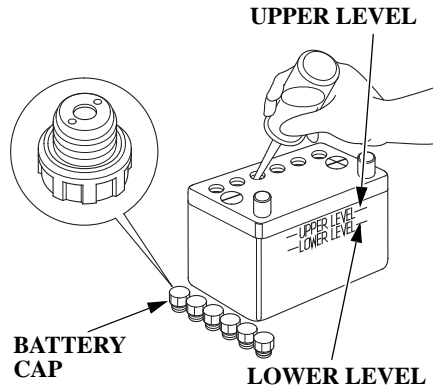

3. Fill the battery with distilled water to the upper level line. Never overfill the battery.
4. Store the battery on a level surface in a cool, dry, well ventilated place out of direct sunlight.
5. Once a month, check the specific gravity of the electrolyte and recharge as required to prolong battery life.

Outboard Motor Position



Transport and store the outboard motor either vertically, as shown above. Attach the stern bracket to stand and secure the outboard motor with bolts and nuts. Store the outboard motor in a well-ventilated area free from direct sunlight and humidity.

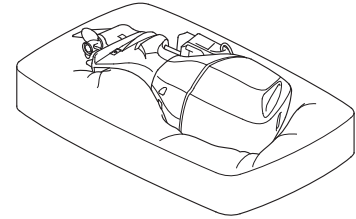

▲ CAUTION

Do not place the outboard motor on its side during a prolonged period of storage. If you are obliged to place the outboard motor on its side, drain the engine oil, protect the outboard motor by wrapping it with the urethane material or the blanket as shown.

To protect the environment, do not dispose of this product, battery, engine oil, etc. carelessly by leaving them in the waste. Observe the local laws and regulations or consult your dealer for disposal.

15. TROUBLESHOOTING

WARNING SYSTEM COMES ON

SYMPTOM	POSSIBLE CAUSE	REMEDY
Overheat warning system comes on: <ul style="list-style-type: none"> • Overheat indicator comes on. • Overheat warning buzzer sounds. • Engine speed decreases and stops at last. • Engine speed cannot be increased by opening the throttle. • Engine will stop in 20 seconds after engine speed is limited. 	Cooling water intake port clogged.	Clean the cooling water intake port.
	Spark plugs have improper heat range.	Replace the spark plugs (see page 86).
	<ul style="list-style-type: none"> • Faulty water pump. • Thermostat clogged. • Faulty thermostat. • Cooling water passage clogged. • Exhaust gas invades cooling system. 	Consult with an authorized TOHATSU outboard motor dealer.
Oil pressure warning system comes on: <ul style="list-style-type: none"> • Oil pressure indicator does not come on. • Oil pressure warning buzzer sounds. • Engine speed decreases. • Engine speed cannot be increased by opening the throttle. 	Shortage of engine oil	Add engine oil to the specified level (see page 41).
	Improper engine oil is used.	Change the engine oil (see page 84).

TROUBLESHOOTING

SYMPTOM	POSSIBLE CAUSE	REMEDY
Water separator warning system comes on: <ul style="list-style-type: none">• Water separator warning buzzer sounds.	Water is accumulated in the water separator.	Drain the water separator (see page 92). Check the fuel tank and fuel line for water accumulation. If the buzzer sounds again, consult with an authorized TOHATSU outboard motor dealer.
PGM-FI warning system comes on: <ul style="list-style-type: none">• PGM-FI indicator comes on.• PGM-FI warning buzzer sounds intermittently.	PGM-FI warning system is faulty.	Consult with an authorized TOHATSU outboard motor dealer.
ACG warning system comes on: <ul style="list-style-type: none">• ACG indicator comes on.• ACG warning buzzer sounds intermittently.	Battery voltage is too high or low.	Check the battery (see page 98).
	Faulty ACG.	Consult with an authorized TOHATSU outboard motor dealer.

16. SPECIFICATIONS

MODEL	BFT250A
Description Code	BBJJ
Type	XD, XU
Overall length	920 mm (36.2 in)
Overall width	625 mm (24.6 in)
Overall height	1,887 mm (74.3 in)
Transom height (when Transom angle is 12°)	635 mm (25.0 in)
Dry mass (weight)*	284 kg (626 lbs)
Rated power	183.9 kW (250 PS)
Full throttle range	5,300 – 6,300 min ⁻¹ (rpm)
Engine type	4 stroke OHC 6-cylinder (V6)
Displacement	3,583 cm ³ (218.6 cu-in)
Spark plug gap	1.0 – 1.1 mm (0.039 – 0.043 in)
Remote control steering system	Motor-mounted
Starter system	Electric starter
Ignition system	Full transistor battery
Lubrication system	Trochoid pump pressure lubrication
Specified oil	Engine: API standard SG, SH, SJ SAE 10W-30 Gear case: API standard GL-4 SAE 90 Hypoid gear oil

Oil capacity	Engine: Without oil filter replacement: 7.6 L (8.0 US qt, 6.7 Imp qt) With oil filter replacement: 7.8 L (8.2 US qt, 6.9 Imp qt) Gear case: 1.47 L (1.55 US qt, 1.29 Imp qt)
D.C. output	12V – 60A
Cooling system	Water cooling with thermostat
Exhaust system	Water exhaust
Spark plugs	ZFR6K-11E (NGK)
Fuel pump	Low pressure side: mechanical type High pressure side: electrical type
Fuel	Automotive unleaded gasoline (91 research octane, 86 pump octane, or higher)
Gear shift	Dog type: Forward – Neutral – Reverse
Steering angle	30° right and left
Trim angle	– 4° to 16° (when Transom angle is 12°)
Tilt up angle	68° (when Transom angle is 12°)

* Without battery cable, with propeller

This TOHATSU outboard is power rated in accordance with ISO8665 (propeller shaft output).

Noise and Vibration

MODEL	BFT250A
CONTROL SYSTEM	R (Remote control)
Sound pressure level at operator's ears (2006/42/EC, ICOMIA 39-94)	83 dB (A)
Uncertainty	2 dB (A)
Measured sound power level (Reference to EN ISO3744)	96 dB (A)
Uncertainty	2 dB (A)
Vibration level at hand arm (2006/42/EC, ICOMIA 38-94)	Not exceed 2.5 m/s ²
Uncertainty	—

Reference to: ICOMIA Standard: as it specifies the engine operating conditions and measurement conditions.

17. "EC DECLARATION OF CONFORMITY" CONTENT OUTLINE

1) EC-DECLARATION OF CONFORMITY	
2) THE UNDERSIGNED, (15), REPRESENTING THE MANUFACTURER, HEREWITH DECLARES THAT THE PRODUCT IS IN CONFORMITY WITH THE PROVISIONS OF THE FOLLOWING EC-DIRECTIVES	
2006/42/EC, 2004/108/EC	
3) REFERENCE TO HARMONIZED STANDARDS: EN ISO 8178 EN ISO 14509	
4) DESCRIPTION OF THE MACHINERY	
5) Generic denomination: Outboard engine 6) Function: Propulsion system 7) MAKE: Honda	
8) TYPE:	9) SERIAL NUMBER:
<input type="text"/>	<input type="text"/>
10) Manufacturer: Honda Motor Co., Ltd. 2-1-1 Minamiaoyama Minato-ku Tokyo 107-8556 Japan	
11) Authorized representative and able to compile the technical documentation: Honda Motor Europe Ltd Belgian Branch p/a Honda Motor Europe Ltd - Aalst Office Wijngaardveld 1 (Noord V) B-9300 Aalst (Belgium)	
12) SIGNATURE:	
<input type="text"/>	
13) NAME:	16) DATE:
<input type="text"/>	<input type="text"/>
14) TITLE:	17) PLACE:
<input type="text"/>	<input type="text"/>

“EC DECLARATION OF CONFORMITY” CONTENT OUTLINE

<p>1) DECLARATION CE DE CONFORMITE 2) LE SOUSSIGNÉ, (15), REPRÉSENTANT DU CONSTRUCTEUR, DÉCLARE PAR LA PRÉSENTE QUE LE PRODUIT EST CONFORME AUX DISPOSITIONS DES DIRECTIVES CE SUIVANTES 3) RÉFERENCE AUX NORMES HARMONISÉES 4) DESCRIPTION DE MACHINE 5) Denomination générique: moteur hors-bord 6) Fonction : Système de propulsion 7) MARQUE 8) TYPE 9) NUMÉRO DI SERIE 10) CONSTRUCTEUR 11) Représentant autorisé et en charge des éditions de documentation techniques 12) SIGNATURE 13) NOM 14) TITRE 15) Directeur Qualité 16) DATE 17) LIEU</p>	français (FRENCH)
<p>1) DICHIARAZIONE DI CONFORMITA' CE 2) IL SOTTOSCRITTO, (15), RAPPRESENTANTE DEL COSTRUTTORE, DICHIARA QUI DI SEGUITO CHE IL PRODOTTO E' CONFORME A QUANTO PREVISTO DALLE SEGUENTI DIRETTIVE COMUNITARIE 3) RIFERIMENTO ALLE NORME ARMONIZZATE 4) DESCRIZIONE DELLA MACCHINA 5) Denominazione generica: MOTORE FUORIBORDO 6) Funzione : Sistema di propulsione 7) MARCA 8) TIPO 9) NUMERO DI SERIE 10) FABBRICANTE 11) Rappresentante autorizzato e competente per la compilazione della documentazione tecnica 12) FIRMA 13) NOME 14) TITOLO 15) DIRETTORE DELLA QUALITA' 16) ADDÌ 17) LUOGO</p>	italiano (ITALIAN)
<p>1) EG-KONFORMITÄTSEKKLÄRUNG 2) DER UNTERZEICHNER, (15), DER DEN HERSTELLER VERTRITT, ERKLÄRT HIERMIT, DAB DAS PRODUKT IN ÜBEREINSTIMMUNG MIT DEN BESTIMMUNGEN DER NACHSTEHENDEN EG-RICHTLINIEN IST 3) VERWEIS AUF HARMONISIERTE NORMEN 4) BESCHREIBUNG DER MASCHINE 5) Allgemeine Bezeichnung : Außenbordmotor 6) Funktion : Antriebsart 7) FABRIKAT 8) TYP 9) SERIEN NUMMER 10) HERSTELLER 11) Bevollmächtigter und in der Position, die technische Dokumentation zu erstellen 12) UNTERSCHIFT 13) NAME 14) TITEL 15) Qualitätssicherung 16) DATUM 17) ORT</p>	deutsch (GERMAN)
<p>1) EG-VERKLARING VAN OVEREENSTEMMING 2) ONDERGETEKENDE, (15), VERTEGENWOORDIGER VAN DE FABRIKANT, VERKLAART HIERMEE DAT HET PRODUCT VOLDOET AAN DE BEPALINGEN VAN DE VOLGENDE EG-RICHTLIJNEN 3) REFERENTIE NAAR GEHARMONISEERDE NORMEN 4) BESCHRIJVING VAN DE MACHINE 5) Algemene benaming : buitenboordmotor 6) Functie : Aandrijfsysteem 7) FABRIKAT 8) TYPE 9) SERIEN UMMER 10) FABRIKANT 11) Gemachtigde van de fabrikant en in staat om de technische documentatie samen te stellen 12) HANDTEKENING 13) NAAM 14) TITEL 15) Directeur Kwaliteitszorg 16) DATUM 17) PLAATS</p>	nederlands (DUTCH)
<p>1) ΕΚ-ΔΗΛΩΣΗ ΕΝΑΡΜΟΝΙΣΗΣ 2) Ο ΥΠΟΓΡΑΦΩΝ, (15), ΕΚΠΡΟΣΩΠΟΝΤΑΣ ΤΟΝ ΚΑΤΑΣΚΕΥΑΣΤΗ, ΔΙΑ ΤΟΥ ΠΑΡΟΝΤΟΣ ΔΗΛΩΝΕΙ ΟΤΙ ΤΟ ΠΡΟΪΟΝ ΒΡΙΣΚΕΤΑΙ ΣΕ ΕΝΑΡΜΟΝΙΣΗ ΜΕ ΤΙΣ ΠΡΟΒΛ ΕΦΕΙΣ ΤΩΝ ΚΑΤΩΘΙ ΟΔΗΓΙΩΝ ΤΗΣ ΕΕ 3) ΠΑΡΑΠΟΜΠΗ ΣΤΑ ΕΝΑΡΜΟΝΙΣΜΕΝΑ ΠΡΟΤΥΠΑ 4) ΠΕΡΙΓΡΑΦΗ ΜΗΧΑΝΗΜΑΤΟΣ 5) Γενική ονομασία : Εξολέμβια μηχανή 6) Λειτουργία : Σύστημα Πρόωσης 7) ΕΡΓΟΣΤΑΣΙΟ ΚΑΤΑΣΚΕΥΗΣ 8) ΤΥΠΟΣ 9) ΑΡΙΘΜΟΣ ΣΕΙΡΑΣ 10) ΚΑΤΑΣΚΕΥΑΣΤΗΣ 11) Εξουσιοδοτημένος αντιπρόσωπος και είναι σε θέση να καταρτίσει τον τεχνικό φάκελο 12) ΥΠΟΓΡΑΦΗ 13) ΟΝΟΜΑ 14) ΤΙΤΛΟΣ 15) Υπεύθυνος Ποιότητας 16) ΗΜΕΡΟΜΗΝΙΑ 17) ΤΟΠΟΣ</p>	Ελληνικά (GREEK)
<p>1) EF OVERENSSTEMMELSESEKKLÆRING 2) UNDERTEGNEDE, (15), DER REPRÆSENTERER FABRIKANTEN, ERKLÆRER HERMED AT PRODUKTET ER I OVERENSSTEMMELSE MED BESTEMMELSENE I FØLGE EF DIREKTIVERNE 3) REFERENCE TIL HARMONISEREDE STANDARDER 4) BESKRIVELSE AF MASKINEN 5) FÆLLESBETEGNELSE : Utembordsmotor 6) ANVENDELSE : Fremdrivningssystem 7) FABRIKANT 8) TYPE 9) SERIEN UMNER 10) FABRIKANT 11) AUTORISERET REPRÆSENTANT OG I STAND TIL AT UDARBEJDE DEN TEKNISKE DOKUMENTATION 12) SIGNATURE 13) NAVN 14) TITEL 15) Kvalitets Leder 16) DATO 17) STED</p>	dansk (DANISH)

“EC DECLARATION OF CONFORMITY” CONTENT OUTLINE

<p>1) DECLARACIÓN DE CONFORMIDAD 2) EL ABAJO FIRMANTE, (15), EN REPRESENTACIÓN DE FABRICANTE, DECLARA QUE EL PRODUCTO ES CONFORME CON LAS DISPOSICIONES DE LAS SIGUIENTES DIRECTIVAS CE 3) REFERENCIA A ESTÁNDARES ARMONIZADOS 4) DESCRIPCIÓN DE LA MAQUINARIA 5) Denominación genérica : Motor fueraborda 6) Función : Sistema de propulsión 7) MARCA 8) TIPO 9) NUMERO DE SERIE 10) FABRICANTE 11) Representante autorizado que puede compilar el expediente técnico 12) FIRMA 13) NOMBRE 14) CARGO 15) Director de calidad 16) FECHA 17) LUGAR</p>	español (SPANISH)
<p>1)DECLARAÇÃO CE DE CONFORMIDADE 2) O ABAIXO ASSINADO, (15), EM REPRESENTAÇÃO DO FABRICANTE, PELA PRESENTE DECLARA QUE O PRODUTO ESTÁ EM CONFORMIDADE COM O ESTABELECIDO NAS SEGUINTE DIRECTIVAS COMUNITÁRIAS 3) REFERÊNCIA AS NORMAS HARMONIZADAS 4) DESCRIÇÃO DA MÁQUINA 5) Denominação genérica : Motor fora de borda 6) Função : Sistema propulsor 7) MARCA 8) TIPO 9) NUMERO DE SERIE 10) FABRICANTE 11) Mandatário com capacidade para compilar documentação técnica 12) ASSINATURA 13) NOME 14) TÍTULO 15) Director de Qualidade 16) DATA 17) LOCAL</p>	português (PORTUGUESE)
<p>1) EY-VAATIMUSTENMUKAISUUSVAKUUTUS 2) ALLEKIRJOITTANUT, (15), JOKA EDUSTAA VALMISTAJAA, VAKUUTTAAN TÄTEN, ETTÄ TUOTE ON SEURAAVIEN EU-DIREKTIIVIN VAATIMUSTEN MUKAINEN 3) VIITTAUS YHTEISIIN STANDARDEIHIN 4) KUVAUS LAITTEESTA 5) Yleisarvomäärä : Peramoottori 6) Toiminto : Työntöjärjestelmä 7) MERKKI 8) MALLI 9) SARJANUMERO 10) VALMISTAJA 11) Valmistajan edustaja ja teknisten dokumenttien laatia 12) ALLEKIRJOITUS 13) NIMI 14) TITTELI 15) Laatupäällikkö 16) PÄIVÄMÄÄRÄ 17) PAIKKA</p>	suomi / suomen kieli (FINNISH)
<p>1) ЕО-ДЕКЛАРАЦИЯ ЗА СЪОТВЕТСТВИЕ 2) ДОЛУ ПОДШИИСАЛИЯТ СЕ (15), ПРЕДСТАВЛЯВАЩ ДИСТРИБУТОРА, ДЕКЛАРИРА, ЧЕ ПРОДУКТА СЪОТВЕТСТВА НА ИЗСКВАНИЯТА НА СЛЕДНИТЕ ЕВРОПЕЙСКИ ДИРЕКТИВИ 3) СЪОТВЕТСТВИЕ С ХАРМОНИЗИРАНИТЕ СТАНДАРТИ 4) ОПИСАНИЕ НА АРТИКУЛА 5) Общо наименование : ИЗВЪН БОРДОВИ ДВИГАТЕЛ 6) Функция : Задвижваща система 7) МАРКА 8) ТИП 9) СЕРИЕН НОМЕР 10) ПРОИЗВОДИТЕЛ 11) Упълномощен представител и отговорник за съставяне на техническа документация 12) ПОДПИС 13) ИМЕ 14) ТИТЛА 15) МЕНИДЖЪР НА КАЧЕСТВОТО 16) ДАТА 17) МЯСТО</p>	български (BULGARIAN)
<p>1) EG-FÖRSÄKRAN OM ÖVERENSSTÄMMELSE 2) UNDERTECKNAD, (15), REPRESENTERANDE TILLVERKARE, FÖRSÄKRAR HÄRMED ATT PRODUKTEN ÖVERENSSTÄMMER MED BESTÄMMELSERNA I FÖLJANDE EG-DIREKTIVE 3) REFERERANDE TILL HARMONISERADE STANDARDER 4) BESKRIVNING AV UTRUSTNINGEN 5) Allmän benämning : Utomborosmotor 6) Funktion : Framdrivningssystem 7) MERKKI 8) TYYPBETECKNING 9) SERIENUMER 10) TILLVERKARE 11) Auktoriserad representant och ska kunna sammanställa teknisk dokumentationen. 12) SIGNATUR 13) NAMN 14) TITEL 15) Kvalitetschef 16) DATUM 17) ORT</p>	svenska (SWEDISH)
<p>1) DEKLARACJA ZGODNOSCI WE 2) NIŻEJ PODPISANY (15), REPREZENTUJĄCY PRODUCENTA, DEKLARUJE Z CAŁĄ ODPOWIEDZIALNOŚCIĄ, ŻE PRODUKT SPEŁNIA WYMAGANIA ZAWARTE W NASTĘPUJĄCYCH DYREKTYWACH UNIJNYCH 3) ZASTOSOWANE NORMY ZHARMONIZOWANE 4) OPIS URZĄDZENIA 5) Ogólne określenie : Silnik zaburtowy 6) Funkcja : Układ napędowy 7) MАРКА 8) ТYP 9) NUMERY SERYJNE 10) PRODUCENT 11) Upoważniony Przedstawiciel oraz osoba upoważniona do przygotowania dokumentacji technicznej 12) PODPIS 13) NAZWISKO 14) TYTUŁ 15) Menadżer Jakości 16) DATA 17) MIEJSCE</p>	polski (POLISH)

“EC DECLARATION OF CONFORMITY” CONTENT OUTLINE

<p>1) MEGFELELŐSEGI NYILATKOZAT 2) ALULÍROTT (15), MINT A GYÁRTÓ KÉPVISELŐJE NYILATKOZIK, HOGY AZ ALABBI TERMÉK MINDENBEN MEGFELEL A KÖVETKEZŐ EC ELŐÍRÁSOK RENDELKEZÉSEINEK: 98/37/EC, 89/336/EEC-93/68/EC: 3) ÖSSZHANGBAN A KÖV. SZABVÁNYOKKAL 4) A GÉP LEÍRÁSA 5) Általános megnevezés : KÜLSŐ CSÓNAKMOTOR 6) Funkció : Hajtás rendszer 7) GYÁRTOTTA 8) TÍPUS 9) SORSZÁM 10) GYÁRTÓ 11) Meghatalmazott képviselője és képes összeállítani a műszaki dokumentációt. 12) ALÁÍRÁS 13) NÉV 14) BEOSZTÁS 15) MINŐSÉGI IGAZGATÓ 16) KELTEZÉS DÁTUMA 17) KELTEZÉS HELYE</p>	magyar (HUNGARIAN)
<p>1) Prohlášení o shodě 2) ZÁSTUPCE VÝROBCE, (15), SVÝM PODPÍSEM POTVRZUJE, ŽE DANÝ VÝROBEK JE V SOULADU S NÁSLEDUJÍCÍMI SMĚRNICEMI A NORMAMI EVROPSKÉHO SPOLEČENSTVÍ: 3) ODKAZ NA HARMONIZOVANÉ NORMY: 4) POPIS VÝROBKU 5) Všeobecné označení : ZÁVĚSNÝ LODNÍ MOTOR 6) Funkce : Pohonný systém 7) ZNAČKA: 8) TYP: 9) VÝROBNÍ ČÍSLO: 10) VÝROBCE: 11) Zplnomocněný zástupce a osoba pověřená kompletačí technické dokumentace 12) PODPIS: 13) JMÉNO: 14) POZICE 15) Manažer kvality 16) DATUM: 17) MÍSTO:</p>	čeština (CZECH)
<p>1) ES VYHLÁSENIE O ZHODE 2) DOLUPODPÍSANÝ, (15), ZASTUPUJÚCI VÝROBCU, TÝMTO DEKLARUJE, ŽE PRODUKT JE V SÚLADE S USTANOVENIAMÍ NASLEDOVNÝCH SMERNÍC ES 3) REFERENCIA K HARMONIZOVANÝM ŠTANDARDOM 4) IDENTIFIKÁCIA STROJVOJ 5) Druhové označenie : ZÁVESNÝ LODNÝ MOTOR 6) Funkcia : Systém pohonu 7) VÝROBCA/ZNAČKA 8) TYP 9) SERIOVÉ ČÍSLO 10) VÝROBCA 11) Autorizovaný zástupca schopný zostaviť technickú dokumentáciu 12) PODPIS 13) MENO 14) POZÍCIA 15) MANAŽÉR KVALITY 16) DÁTUM 17) MIESTO</p>	slovenčina (SLOVAK)
<p>1) EF SAMSVARSÆRKLERING 2) UNDERTEGNEDE, (15), SOM REPRESENTERER FABRIKANTEN, ERKLÆRER HERVED AT PRODUKTET ER I OVERENSSTEMMELSE MED BESTEMMELSENE I FØLGENDE EU DIREKTIV 3) REFERANSER TIL HARMONISEREDE STANDARDER 4) BESKRIVELSE AV MASKINEN 5) Felles benevnelse : Utenbordsmotor 6) Funksjon : Fremdrifts system 7) FABRIKANT 8) TYPE 9) SERIE NUMMER 10) FABRIKANT 11) Autorisert representant og i stand til å utarbeide den tekniske dokumentasjonen 12) SIGNATUR 13) NAVN 14) TITTEL 15) Kvalitetssjef 16) DATO 17) STED</p>	norsk (NORWEGIAN)
<p>1) DECLARATIE DE CONFORMITATE. 2) SUBSEMNATUL, (15), REPREZENTAND PE PRODUCATOR, DECLAR PRIN PREZE NTA CA PRODUSUL ESTE IN CONFORMITATE CU PREVEDERILE URMATOARELOR DIRECTIVE CE 3) REFERIRE LA STANDARDELE ARMONIZATE: 4) DESCRIEREA ECHIPAMENTULUI 5) Denumire generica : MOTOR IN AFARA BORDULUI (EXTERN) 6) Domeniu de utilizare : Sistem de propulsie 7) MARCA 8) TIPUL 9) NUMAR DE SERIE 10) PRODUCATOR 11) Reprezentant autorizat și abilitat să realizeze documentație tehnică 12) SEMNATURA 13) NUME 14) TITLUL 15) DIRECTOR DE CALITATE 16) DATA 17) LOCATIE</p>	română (ROMANIAN)
<p>1) EU VASTAVUSDEKLARATSIOON 2) ALLKIRJUTANU, (15), ESINDADES TOOTJAT, DEKLAREERIB SIINKOHAL, ET TOODE ON VASTAVUSES JÄRGMISTE EC DIREKTIIVIDE SÄTETEGA 3) VIIDE ÜHTLUSTATUD STANDARDITELE: 4) MEHHAANISMI KIRJELDUS 5) Üldnimetus : Pardaväliline mootor 6) Funktsioon : Tõukursüsteem 7) VALMISTAJA: 8) TÜÜP: 9) SEERIANUMBER: 10) TOOTJA: 11) Volitatud esindaja, kes on pädev täitma tehnilist dokumentatsiooni 12) ALLKIRI: 13) NIMI: 14) AMET 15) Kvaliteedijuht 16) KUUPÄEV: 17) KOHT:</p>	eesti (ESTONIAN)

“EC DECLARATION OF CONFORMITY” CONTENT OUTLINE

<p>1) EK ATBILSTĪBAS DEKLARĀCIJA 2) ZEMĀK MINĒTAIS, (15), KĀ RAŽOTĀJA PĀRSTĀVIS AR ŠO APSTIPRINA, KA ŠIS PRODUKTS PILNĪBĀ ATBILST VISIEM STANDARTIEM, KAS ĀTRUNĀTI SEKOJOŠAJĀS EC-DIREKTĪVĀS</p> <p>3) Apsaucoties uz saskaņotajiem standartiem 4) Iekārtas apraksts</p> <p>5) Vispārējais nosaukums : Piekarināmais laivas dzinējs 6) Funkcija : Virzošā spēka sistēma</p> <p>7) Preču zīme 8) Tips 9) Sērijas numurs 10) Izgatavotājs 11) Autorizētais pārstāvis, kas spēj sastādīt tehnisko dokumentāciju 12) Paraksts</p> <p>13) Vārds, Uzvārds 14) Tituls 15) Kvalitātes vadītājs 16) Datums 17) Vieta</p>	latviešu (LATVIAN)
<p>1) EB ATITIKTĪES DEKLARĀCIJA 2) ŽĒMIAUI PASIRAŠES, (15), ATSTOVAUJANTIS GAMINTOJĀ DEKLARUOJA KĀD PRODUKTAS ATITINKA REIKALAVĪMUS PAGAL ŠĪAS EB DIREKTĪVAS.</p> <p>3) NUORODA Į HARMONIZUOTUS STANDARTUS. 4) MAŠINOS APRAŠYMAS.</p> <p>5) Bendras pavadinimas : PAKABINAMAS VARIKLIS 6) Funkcija : Varomasis būdas 7) MARKĖ.</p> <p>8) TIPAS 9) SERIJINIS NUMERIS. 10) GAMINTOJAS. 11) Įgaliotasis atstovas ir galintis sudaryti techninę dokumentaciją 12) PARAŠAS.</p> <p>13) V. PAVARDĖ 14) PAREIGOS 15) KOKYBĖS VADYBININKAS. 16) DATA. 17) VIETA</p>	lietuvių kalba (LITHUANIAN)
<p>1) ES-DEKLARACIJA O USTREZNOSTI 2) PODPISANI (15), PREDSTAVNIK PROIZVAJALCA, IZJAVLJAM DA IZDELKI USTREZAJO NASLEDNJIM DEKLARACIJAM</p> <p>3) SKLADNOST Z NASLEDNJIMI STANDARDI 4) OPIS IZDELKOV</p> <p>5) Vrsta stroja : Izvenkrmni motorji 6) Funkcija : Pogonski sistem</p> <p>7) PROIZVAJA 8) TIP 9) SERIJSKA ŠTEVILKA 10) PROIZVAJALEC</p> <p>11) Pooblaščenii predstavnik ki lahko predloži tehnično dokumentacijo</p> <p>12) PODPIS 13) IME 14) FUNKCIJA 15) Direktor presoje 16) DATUM 17) KRAJ</p>	slovenščina (SLOVENIAN)
<p>1) EB-YFIRLYSING 2) UNDIRRITAÐUR HR, (15) LYSI YFIR FYRIR HÖND FRAMLEIÐANDA AÐ VARAN UPPFYLLIR EFTIRFARANDI EC-TILSKIPANIR 3) TILVÍSUN UM HEILDARSTAÐAL 4) LÝSING Á VÉLBÚNAÐI</p> <p>5) Flokkur : Utanborðsmótorar 6) Virkni : knúningsafl kerfi 7) FRAMLEIÐSLA 8) GERÐ 9) SERÍAL NÚMER 10) FRAMLEIÐANDI</p> <p>11) Löggildir aðilar og fær um að taka saman tækniskjölin 12) UNDIRSKRIFT 13) NAFN 14) TITILL</p> <p>15) Skráningarstjóri 16) DAGSETNING 17) STAÐUR</p>	Íslenska (ICELANDIC)
<p>1) AT UYGUNLUK BEYANI 2) AŞAĞIDA İMZASI BULUNAN VE İMALATÇININ YETKİLİ TEMSİLCİSİ OLAN (15) ÜRÜNÜN ŞU AT YÖNETMELİKLERİNİN HÜKÜMLERİNE UYGUN OLDUĞUNU BEYAN EDER.</p> <p>3) UYUMLAŞTIRILMIŞ STANDARTLARA ATIF 4) MAKİNANIN TARIFI</p> <p>5) Flokkur : Diştan takma motor 6) Virkni : tahrik sistemi 7) MARKA 8) TIP</p> <p>9) SERİ NUMARASI 10) İMALATÇI 11) Teknik dosyayı hazırlamakla yetkili olan Toplulukta yerleşik yetkili temsilci</p> <p>12) İMZA 13) ADI 14) ÜNVANI 15) Homologasyon Yöneticisi 16) TARİH 17) YER</p>	Türk (TURKISH)
<p>1)EK-IZJAVA O SUKLADNOSTI 2)POTPIŠANI (15), PREDSTAVNIK PROIZVOĐAČA, IZJAVLJUJE DA JE PROIZVOD U SUKLADNOSTI S ODREDBAMA SLJEDEĆEG EK PROPISA</p> <p>3)REFERENCA NA USKLAĐENE NORME 4)OPIS STROJA</p> <p>5)Opća vrijednost : Vanbrodski motor 6)Funkcionalnost : Pogonski sustav</p> <p>7)IZRADIO 8)TIP</p> <p>9)SERIJSKI BROJ 10)PROIZVOĐAČ 11) Ovlašteni predstavnik i osoba za sastavljanje tehničke dokumentacije 12) POTPIS 13) IME</p> <p>14) TITULA 15) Upravitelj homologacije 16) DATUM 17) MJESTO</p>	hrvatski (CROATIAN)

A	E	
ACG Fuse 101	“EC DECLARATION OF CONFORMITY” Content Outline 114	Water Separator Warning System..... 69
ACG Indicator/Buzzer..... 20	Emergency Stop Switch 25	Serial Number 3
Anodes	Switch Lanyard/Clip..... 25	Switch 18
Function..... 27	Spare Switch Clip 26	
Operation 74	Emission Control System..... 97	F
B	Engine	Frame Serial Number 3
Battery	Cover	Fast Idle
Cleaning..... 99	Latch 28	Button..... 19
Connections 34	Removal/Installation..... 39	Lever 19
Electrolyte Level Inspection..... 98	Oil	Fuel
Leads Inspection..... 46	Change 84	Filter 91
Storage..... 107	Level Inspection 41	Inspection..... 92
Break-in Procedure 56	Refilling..... 41	Replacement..... 93
	Protection System 69	Level 41
C	ACG Warning System..... 69	Line
Cleaning and Flushing 79	Anode 73	Connection 38
Component Identification 10	Oil Pressure Warning System 69	Disconnection 77
Controls and Features 15	Overheat Warning System.... 69	Priming..... 48
Cooling Water	Over-rev Limiter..... 73	Storage 105
Check Hole 28	PGM-FI Warning System..... 69	Fuse Replacement 100
Intake Port 28		
Cruising 60		
D		
Disposal 109		

INDEX

G

Gasoline Containing Alcohol 43

Gear

Shifting 57, 58, 59

I

Installation

Outboard Motor 32

Height 31

Location 31

Inspect After Operating 103

Interface Coupler 29

L

Lubrication 90

M

Maintenance 80

Maintenance Schedule 82

Manual Relief Valve

Function 24

Operation 67

Moorage

Power Trim/Tilt Type 66

Multiple Outboard Motors 74

N

Neutral Release Lever 18

O

Oil Pressure Indicator/Buzzer 21

Operation

Gear Shifting 57, 58, 59

Outboard Motor

Installation 32

Storage Position 108

Outboard Motor Angle

Inspection 33

Over-rev Limiter 73

Overheat Indicator/Buzzer

Function 21

Operation 69

P

PGM-FI Indicator/Buzzer 20

Power Tilt Switch

Function 23

Operation 67

Power Trim/Tilt Switch

Function 22

Operation 60

Pre-operation Checks 39

Battery 46

Engine Oil 40

Fuel 42

Fuel Filter 45

Other Checks 47

Propeller and Cotter Pin

Inspection 44

Remote Control Lever

Friction 45

Propeller

Inspection 44

Replacement 102

Selection 38

R

Remote Control

Box

Identification 12, 13

Installation Location 37

Cable Length 37

Installation 36

Lever

Function 15, 16, 17

Friction Adjustment 45

S	T	V
Safety	Tachometer 29	Vapor Separator Draining 106
Carbon Monoxide Poisoning	Tilt Lock Lever 27	W
Hazard 7	Tilting the Outboard Motor	Water Separator Buzzer 21
Information..... 6	Remote Control Type 65	Water Separator
Label Locations 8	Tool Kit and Spare Parts 47, 81	Cleaning 94
Operator Responsibility..... 6	Trailerling 78	
Shallow Water Operation 73	Transom	
Spare Clip, Emergency Stop	Height 30	
Switch..... 26	Transporting..... 77	
Spark Plugs 86, 89	Trim Meter	
Specifications 112	Function 23	
Starting the Engine	Operation 64	
R1 type48	Trim Tab	
R2, R3 types52	Operation 27	
Stopping the Engine	Adjustment..... 68	
Emergency.....75	Trimming the Outboard Motor 62	
Normal Stop75	Troubleshooting	
Storage.....105	Warning System Operation..... 110	
Submerged Outboard Motor		
Servicing.....103		
Switch Panel 13		

MEMO

MEMO

 **TOHATSU**

OWNER'S MANUAL

BFT 250A



EN

OWNER'S MANUAL

FR

MANUEL
DE L'UTILISATEUR

ES

MANUAL
DEL PROPIETARIO

DE

BENUTZERHANDBUCH

BFT 250A

36ZX2T00
00X36-ZX2-T000

TOHATSU CORPORATION

Address : 5-4,AZUSAWA 3-CHOME ITABASHI-KU,
TOKYO 174-0051

Phone : +81-3-3966-3117

FAX : +81-3-3966-2951

URL : www.tohatsu.co.jp

英 仏 西 独 000-00000-0

Printed in Japan